

# ALWAYS THE BEST PROTECTION PROFILES

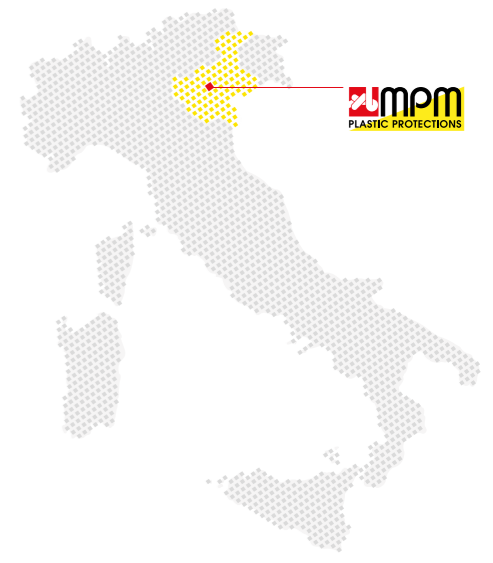

M.P.M. s.r.l.  
Via Europa 2  
35010 Fratte  
di S. Giustina in Colle  
Padova · Italy  
T +39 049 9301773  
F +39 049 9300427  
info@mpmpvc.com  
mpmprotections.com





SAFETY ENGINEERING  
FOR A SAFE WORK

Safeway360

SEGURIDAD GLOBAL

# Exterior & Interior

Protección de personas



Protección de activos y bienes



Señalización temporal y definitiva



Delimitaciones de zonas de trabajo



Diseño y soluciones a medida



ESTUDIO Y PROYECTO



PRODUCTO E INSTALACIÓN



POSTVENTA Y MANTENIMIENTO



PRESENTS NEW MATERIAL



## CONTENTS



page 02

---

01	Rack Protection	page 08	08	BFlex	page 50
02	Bollard	page 16	09	Column Protection	page 58
03	Guard Rails	page 20	10	Loading Bays Protections	page 64
04	Cold Line	page 26	11	Corner Protection	page 66
05	Pedestrian Safety Barriers	page 32	12	Kerb	page 68
06	Doors	page 38	13	Wall Protection	page 72
07	Link	page 44			

---



OUR **PENDULUM MACHINE** FOR CRASH REPORTS

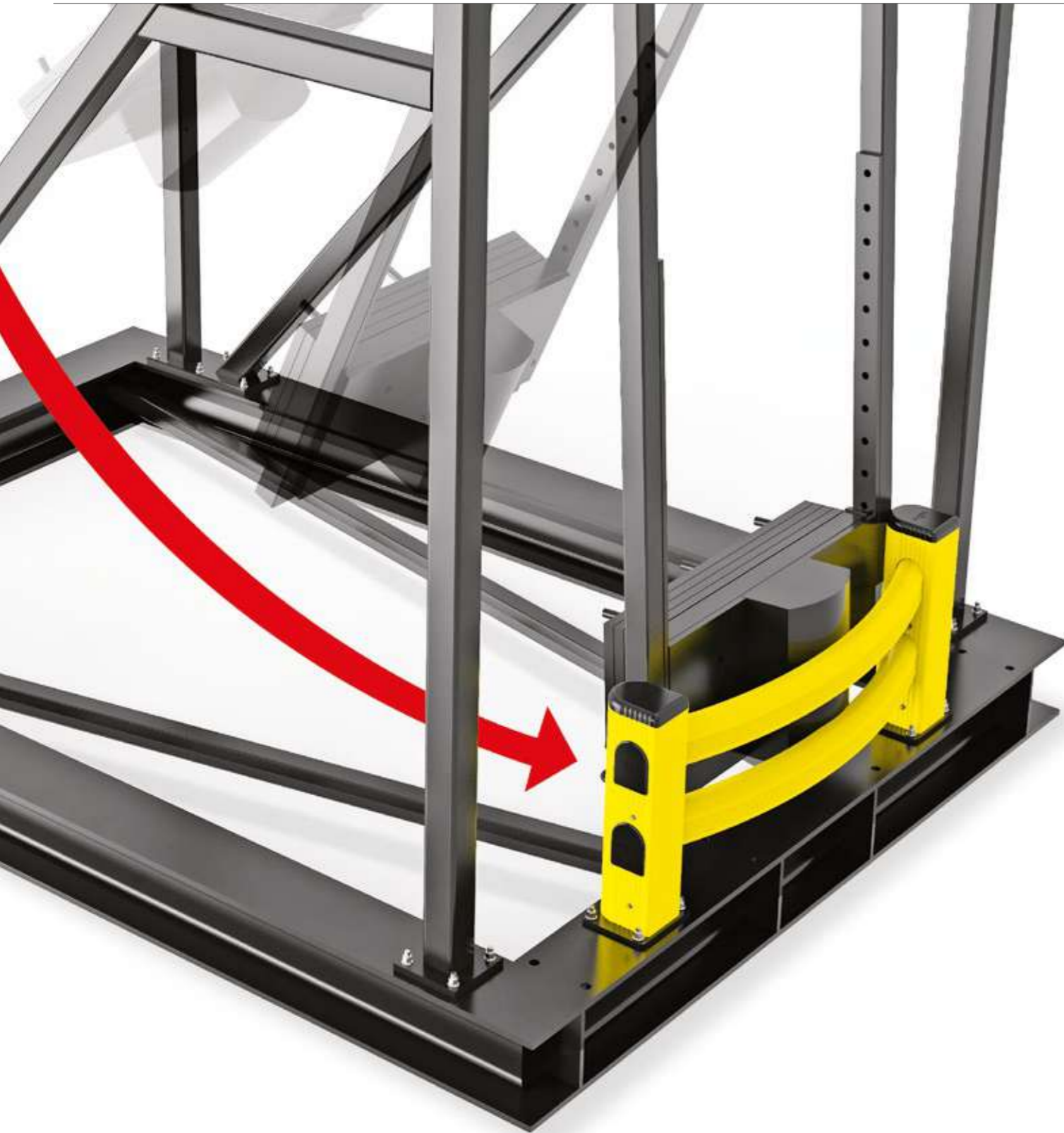

**RESEARCH AND DEVELOPMENT**  
CUSTOMISED PROJECT MANAGEMENT SERVICE

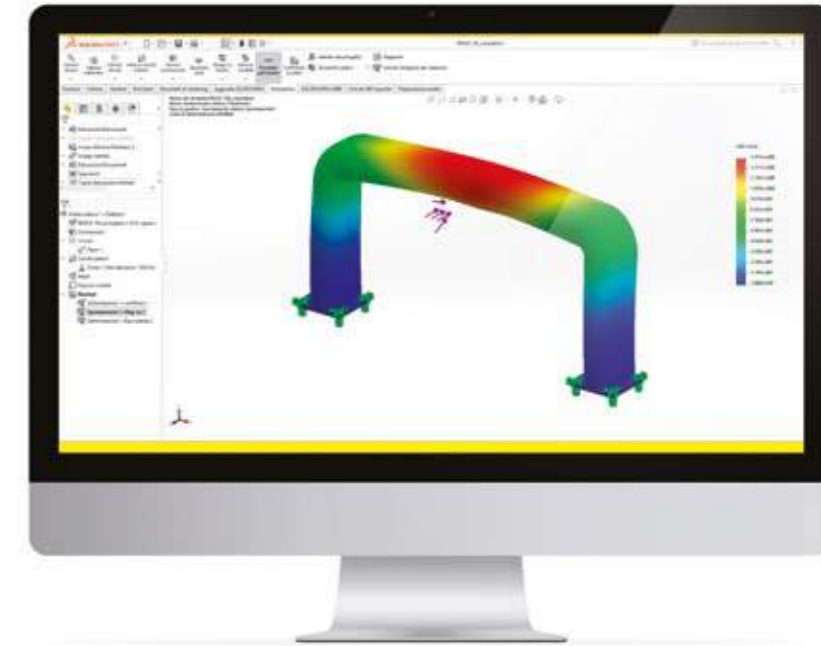







FIRE CLASS V0,  
SELF-EXTINGUISHING,  
NON-FLAME SPREAD  
MATERIAL

FOR FLEXIBLE BARRIER

PROTECTION ARE THE BEST CHOICE IN COMPARISON TO METAL OR OTHER MATERIALS

		METAL	PE/PP	WOOD
				
EASY CLEANING	● ● ● ● ●	● ● ● ● ○	● ● ○ ○ ○	○ ○ ○ ○ ○
SCRATCHES	● ● ● ● ●	● ● ● ○ ○	● ● ● ○ ○	● ○ ○ ○ ○
FLEXIBILITY	● ● ● ● ●	● ○ ○ ○ ○	● ● ● ● ●	● ● ○ ○ ○
SHOCK ABSORBER	● ● ● ● ●	○ ○ ○ ○ ○	● ● ● ● ○	● ● ○ ○ ○
FAST INSTALLATION	● ● ● ● ●	● ● ● ● ●	● ● ● ○ ○	● ● ● ● ○
SAVE SPACE	● ● ● ● ○	● ● ● ● ●	● ● ○ ○ ○	● ● ● ○ ○
FIRE RESISTANT	● ● ● ● ○	● ● ● ● ●	○ ○ ○ ○ ○	○ ○ ○ ○ ○
LONG LASTING	● ● ● ● ●	● ● ● ● ●	● ● ● ○ ○	● ● ○ ○ ○

RESEARCH AND DEVELOPMENT NEVER STOP!

ORANGE LINE

NEWS

AVAILABLE FOR:  
LM / PED 150 /  
TOWER



HIGHER  
VISIBILITY  
FOR A GREATER  
SAFETY!

RESEARCH AND DEVELOPMENT NEVER STOP!

# CLIP 90

# NEWS

AVAILABLE FOR:  
LM / PED 150 /  
TOWER



EASY TO  
INSTALL



CUSTOMIZE  
YOUR BARRIER



MORE  
VISIBILITY

# GENIUS

THE LENGTH THAT YOU WISH

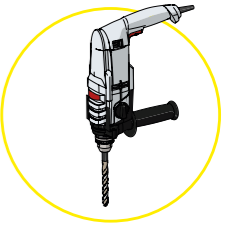

CUT THE RAIL AND DRILL IT WITH GENIUS



FOR YOUR  
PEDESTRIAN  
BARRIERS

FOR YOUR  
HUG TOWER



**NEW!**  
DO IT YOURSELF!

**WORLD'S UNIQUE SYSTEM!**  
**YOUR CUSTOMIZED BARRIER AND HUG TOWER**

# 01

## RACK PROTECTION

OUR PROFILES FIT ALL RACKS

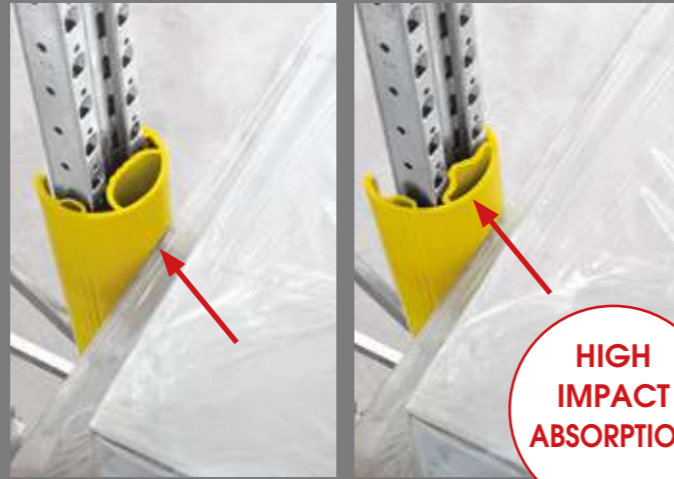

Full range of techno polymer profiles for protection of warehouse racks.

Gamma completa di profili in tecnopolimeri per la protezione di scaffali.

Complète gamme de profilés en tecnopolimère pour la protection d'étagères de dépôts.



Gama completa de perfiles de tecnopolímeros para las protecciones de estanterías.

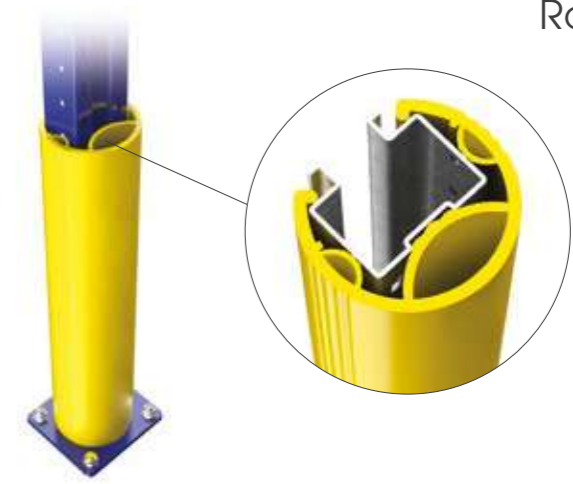

EASY TO INSTALL

THE ONLY ONE WITH TRIPLE SHOCK ABSORBER

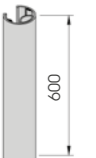
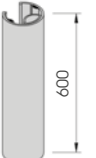

	<b>RPS 600</b> 60 80 Available also size 400	ANTISHOCK MATERIAL INSIDE	Packing 6 pz / box Packing 114 pz / big parcel Colour M	
	<b>RPM 600</b> 80 100 Available also size 400	ANTISHOCK MATERIAL INSIDE	Packing 4 pz / box Packing 80 pz / big parcel Colour M	
	<b>RPL 600</b> 100 120 Available also size 400	ANTISHOCK MATERIAL INSIDE	Packing 2 pz / box Packing 54 pz / big parcel Colour M	
	<b>RPL XL 600</b> 100 120 Available also size 400	ANTISHOCK MATERIAL INSIDE	Packing to be defined Colour M	
	<b>RP CLICK</b>		Packing 1 pz / box	
	<b>RPF 600</b> 60 130 Equipped with accessories	FLEXIBLE	Packing 2 pz / bag Colour M Axle spacing 25 - 50 - 75 mm	
	<b>RACK CORNER</b> Equipped with accessories	ANTISHOCK MATERIAL INSIDE	Packing to be defined Colour M	

# Rack end Barriers

SM



DIFFERENT SIZES ON REQUEST

FAST AND EASY TO INSTALL

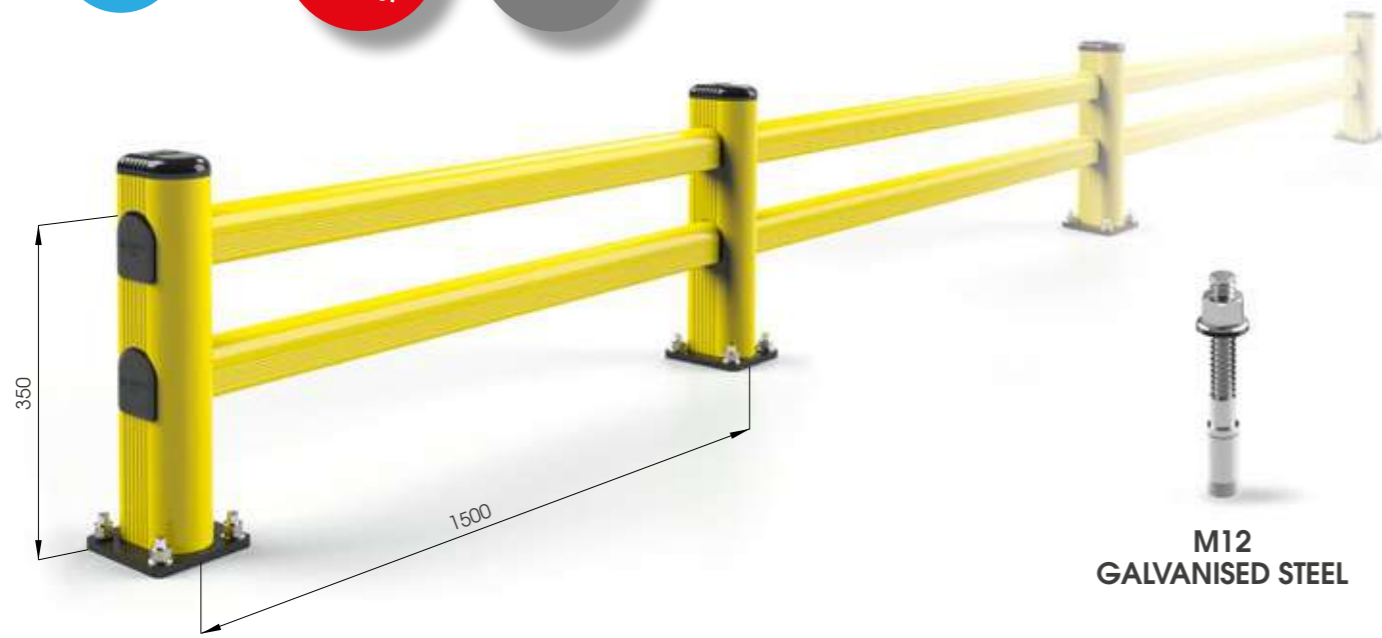

M12 GALVANISED STEEL

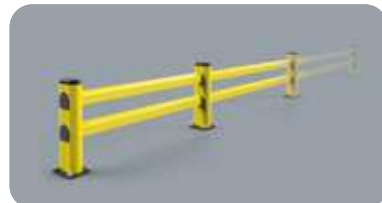

SM 1500x400 MODULAR

Packing Colour **B** **M** unpacked on pallet

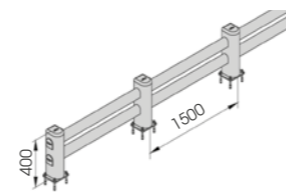

Equipped with accessories



SM 1100x400

Length 1.100 Packing Colour **B** **M** unpacked on pallet

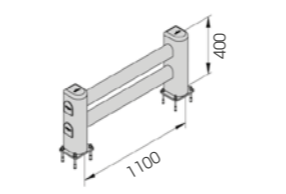

Equipped with accessories



# Rack end Barriers

LM



DIFFERENT SIZES ON REQUEST

FAST AND EASY TO INSTALL

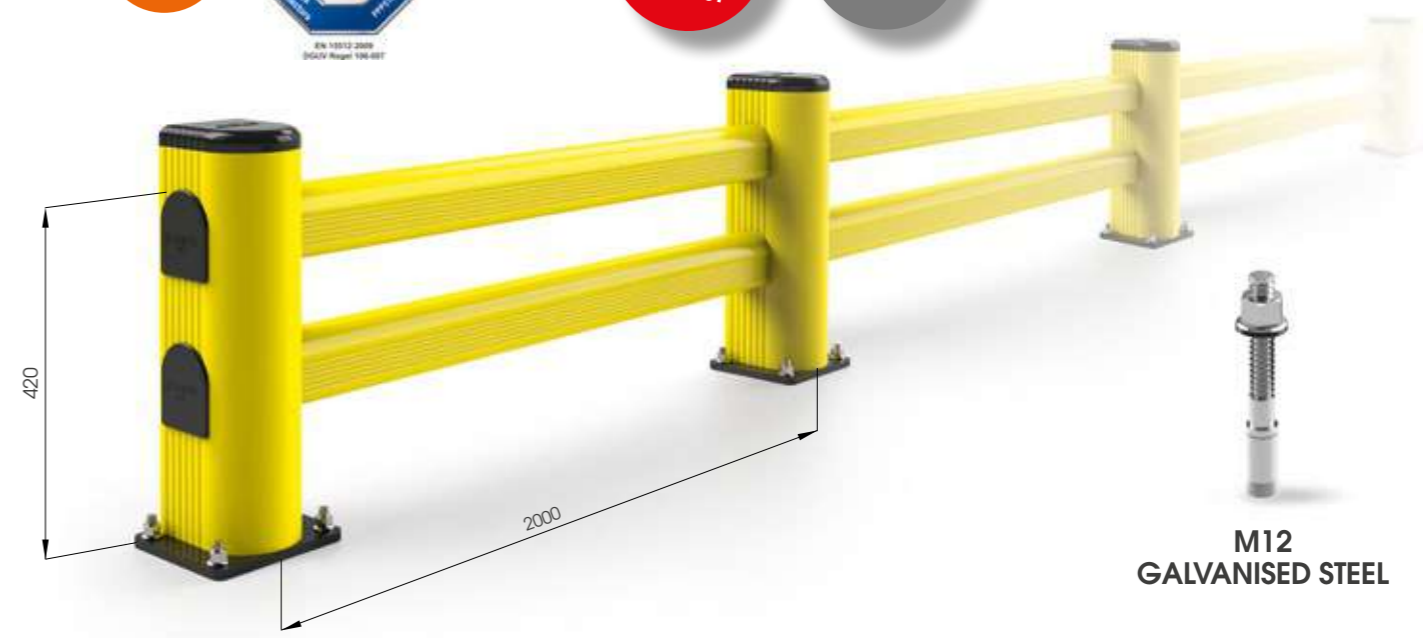

M12 GALVANISED STEEL



LM 2000x500 MODULAR

Packing Colour **B** **M** unpacked on pallet

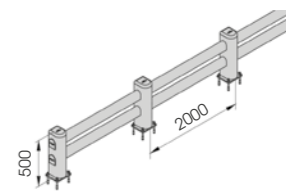

Equipped with accessories



LM 1100x500  
LM 2400x500

Length 1.100 / 2.400 mm Packing Colour **B** **M** unpacked on pallet

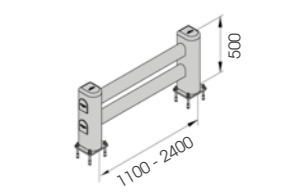

Equipped with accessories





# FENCE 90



DIFFERENT SIZES ON REQUEST

FAST AND EASY TO INSTALL



M12 GALVANISED STEEL



FE 90 1100x350

Length 1.100 mm  
Packing unpacked on pallet  
Colour B M

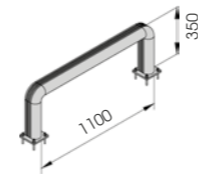

Equipped with accessories



FE 90 2400x350

Length 2.400 mm  
Packing unpacked on pallet  
Colour B M

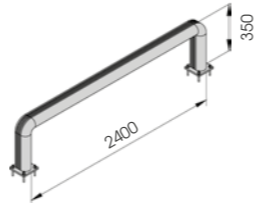

Equipped with accessories



# FENCE 150



DIFFERENT SIZES ON REQUEST

FAST AND EASY TO INSTALL



M12 GALVANISED STEEL



FE 150 1100x550

Length 1.100 mm  
Packing unpacked on pallet  
Colour B M



Equipped with accessories



FE 150 2400x550

Length 2.400 mm  
Packing unpacked on pallet  
Colour B M

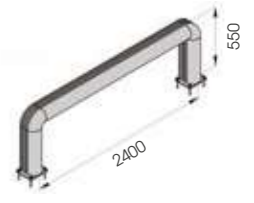

Equipped with accessories



# FENCE 150 REINFORCED



DIFFERENT SIZES ON REQUEST

FAST AND EASY TO INSTALL



FE 150 REF 1100x550

Length 1.100 mm  
Packing unpacked on pallet  
Colour B M



Equipped with accessories



FE 150 REF 2400x550

Length 2.400 mm  
Packing unpacked on pallet  
Colour B M



Equipped with accessories



# FENCE LINK



DIFFERENT SIZES ON REQUEST

FAST AND EASY TO INSTALL



FE LINK 1100x550

Length 1.100 mm  
Packing unpacked on pallet  
Colour B M

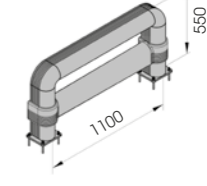

Equipped with accessories

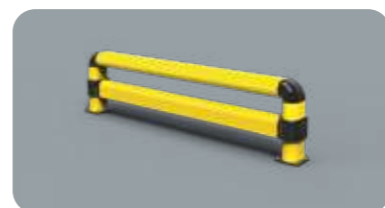

FE LINK 2400x550

Length 2.400 mm  
Packing unpacked on pallet  
Colour B M

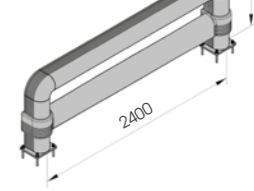

Equipped with accessories



# 02 BOLLARD

Designed to protect access to gates or big doors from huge traffic or simply to mark restricted areas for pedestrians. Fully equipped with fixing accessories.

Ideato per proteggere l'accesso a cancelli o portoni dalla movimentazione di mezzi pesanti o semplicemente per impedire l'ingresso di pedoni. Provisto di accessori di fissaggio.

Étudié pour protéger l'accès aux portes ou entrées de grand trafic ou simplement pour marquer les zones de passage piétons. Equipé avec les accessoires d'installation.

Diseñado para proteger el acceso a puertas o portones del movimiento de vehículos pesados o simplemente para evitar la entrada de peatones. Provisto de accesorios de fijación.

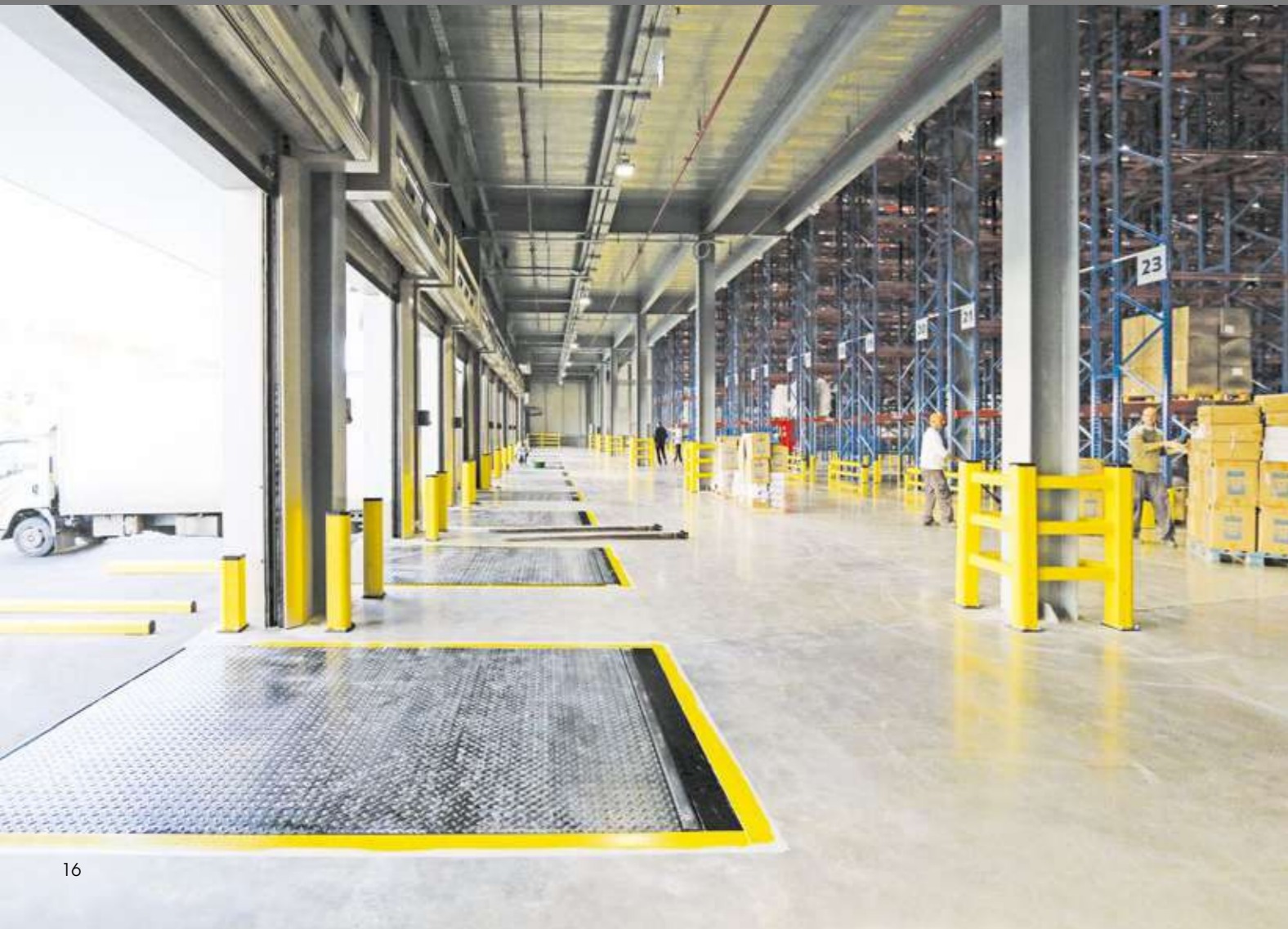

## Bollard

GRD 90



FAST AND EASY TO INSTALL



M12 GALVANISED STEEL



GRD 90 250

Packing Colour **unpacked on pallet**  
 B  M

Equipped with accessories

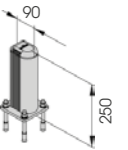

GRD 150



FAST AND EASY TO INSTALL

Bollard



M12 GALVANISED STEEL

GRD 200

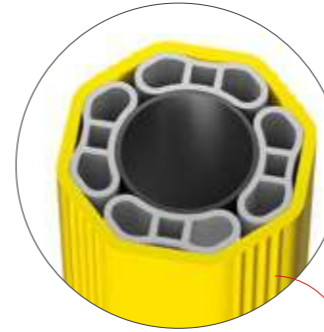

NEW ANTISHOCK BUMPER

Bollard

FAST AND EASY TO INSTALL



S16 GALVANISED STEEL



GRD 150 \* 500  
800  
1150

Equipped with accessories

Packing Colour **B** **M** unpacked on pallet

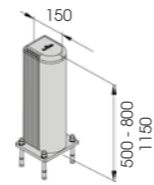

GRD 200 1200  
2000

Equipped with accessories

Packing Colour **M** unpacked on pallet

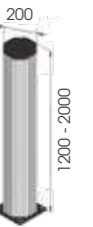

# 03 GUARD RAILS

Sistema profili antiurto specifico per la protezione delle pareti dai carrelli in movimento. Progettato seguendo un innovativo disegno tecnico che coniuga rapidità e semplicità nelle fasi di installazione e pulizia. Disponibile in diverse lunghezze.

Nouveau système bumper, spécifique pour protéger les murs contre les mouvements des charriots. Étudié avec un modern dessin qui regroupe la rapidité et la facilité pendant l'installation et le nettoyage. Disponible en différents longueurs.

Sistema de perfiles anti-impacto específico para la protección de las paredes de los carros en movimiento. Diseñado según un diseño técnico innovador que une velocidad y simplicidad en las fases de instalación y limpieza. Disponible en diferentes longitudes.

A new bumper system specific for the protection of the walls resistant against trolleys movements. Designed by following an innovative technical design that combines speed and simplicity in the steps of installation and cleaning. Available in different lengths.



## TRUCK LINE



DIFFERENT SIZES ON REQUEST



TL	500	2000
	750	3000
	1000	4000
	1500	

Equipped with accessories

Packing Colour to be defined  
B M



# GUARD RAIL 90



QUICK INSTALLATION WITH EXPANSION SCREW



M16 GALVANISED STEEL



ALTERNATIVE FIXING HIGH RESISTANCE WITH RESIN M16 STAINLESS STEEL



GR 90 500  
750  
1000  
1500

Length 500 mm  
Packing unpacked on pallet

Length 750 / 1000 / 1500 mm  
Packing 2 pz / box

Colour B M

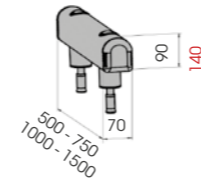

GR 90 2000  
3000  
4000

Length 2.000 / 3.000 / 4.000 mm  
Packing unpacked on pallet

Colour B M

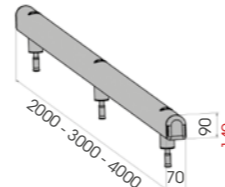

Equipped with accessories

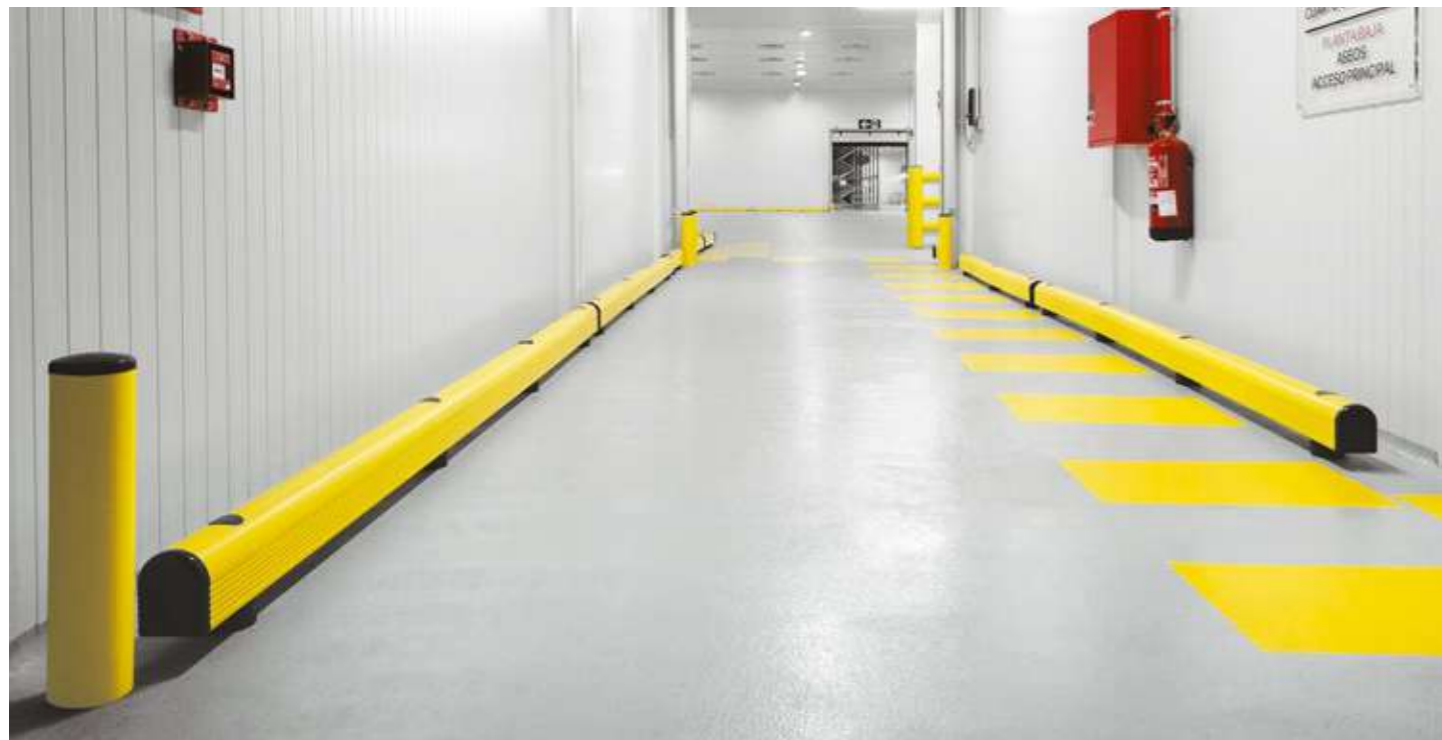

# GUARD RAIL 150



HIGH RESISTANCE WITH RESIN



M20 STAINLESS STEEL



GR 150 500  
750  
1000  
1500

Length 500 / 750 / 1000 / 1500 mm  
Packing unpacked on pallet

Colour B M

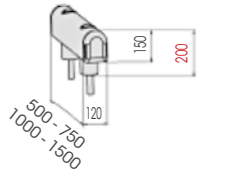

Equipped with accessories

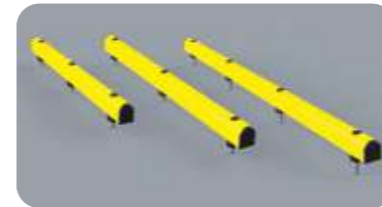

GR 150 2000  
3000  
4000

Length 2.000 / 3.000 / 4.000 mm  
Packing unpacked on pallet

Colour B M

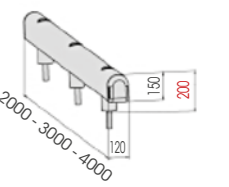

Equipped with accessories



# GRIN 90

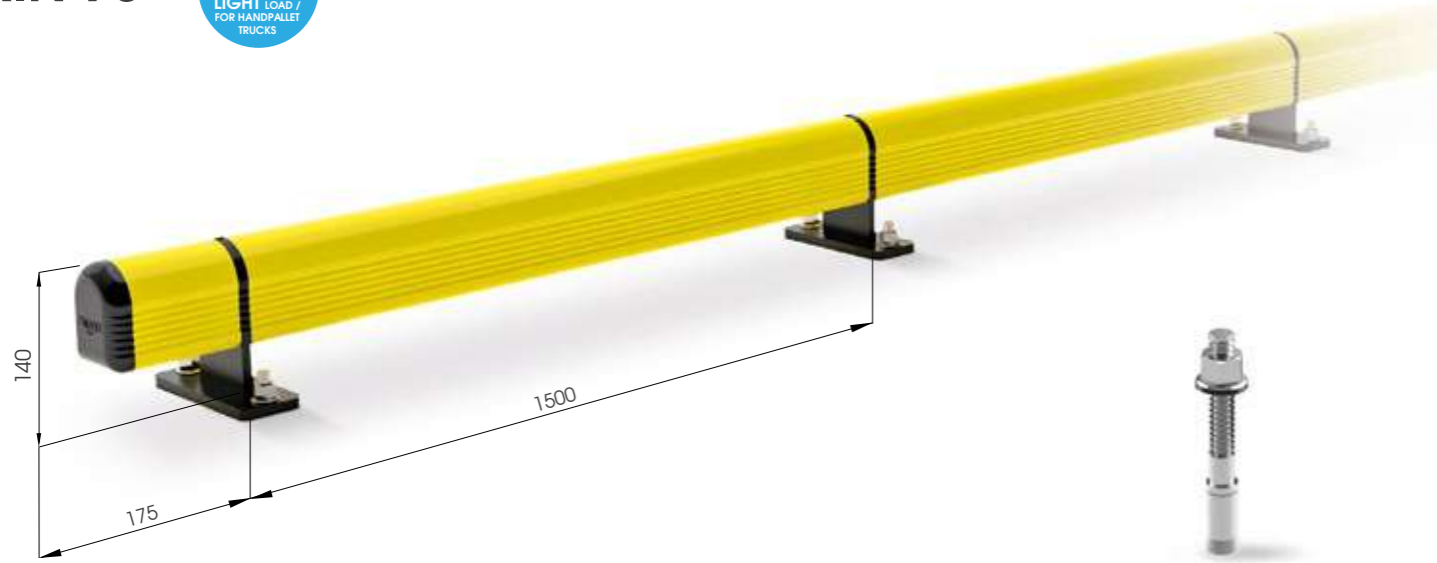

M12 GALVANISED STEEL

# GRIN 150



M12 GALVANISED STEEL



GRIN 90 1500

Length **1500 mm**  
Packing **to be defined**  
Colour **M**



GRINCO 90

Packing **to be defined**  
Colour **M**



Equipped with accessories



GRINT 90

Packing **to be defined**  
Colour **M**



Equipped with accessories



GRIN 150 2000

Length **2000 mm**  
Packing **to be defined**  
Colour **M**

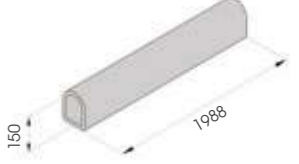

GRINCO 150

Packing **to be defined**  
Colour **M**



Equipped with accessories



GRINT 150

Packing **to be defined**  
Colour **M**



Equipped with accessories



# 04

## COLD LINE

Specific solutions for the protection of areas at risk of impact, in environments with negative temperature. They are suitable to protect corners, entrances, gates, panels and cold rooms walls.

Soluzioni specifiche per la protezione di zone a rischio d'impatto in ambienti a temperatura negativa. Ideali per proteggere angoli sporgenti, accessi e portoni, pannelli e pareti di celle frigorifere.

Solutions spécifiques pour la protection des zones à risque de collision dans les environnements à température négative. Idéal pour protéger les angles, les entrées et les portes, les panneaux et les murs des chambres froides.

Soluciones específicas para proteger las zonas con riesgo de impacto en entornos de temperatura negativa. Son ideales para proteger esquinas, entradas y puertas, paneles y paredes de las cámaras frigoríficas.

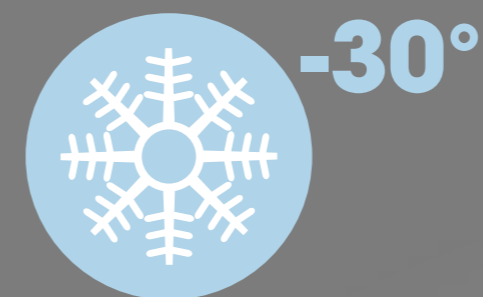

RESISTANT  
TO LOW  
TEMPERATURES





**ROD 70**



**RE**  
EASY TO  
REMOVE AND  
TO REPLACE

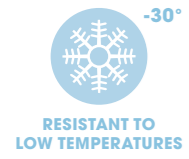

**M20  
GALVANISED STEEL**

Fixing accessory available also in stainless steel



**ROD PE 70 266 RE**

Packing Colour **C**  
1 pz / box

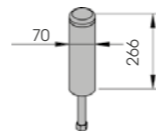

**Drill Ø 38**  
Equipped with accessories



**ROD 120**



**RE**  
EASY TO  
REMOVE AND  
TO REPLACE

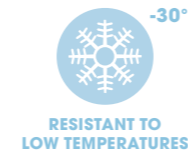

**M30  
GALVANISED STEEL**

Fixing accessory available also in stainless steel



**ROD PE 120 433 RE  
560 RE**

Packing Colour **M**  
1 pz / bag

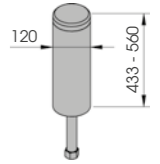

**Drill Ø 56**  
Equipped with accessories



# ROD FLOOR 70



QUICK  
INSTALLATION  
WITH  
EXPANSION  
SCREW



M16  
GALVANISED STEEL

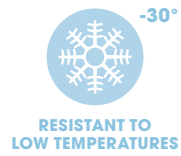

RESISTANT TO  
LOW TEMPERATURES



RF 70 500  
1000  
1500

Length 500 / 1000 / 1500 mm  
Packing unpacked on pallet  
Colour M

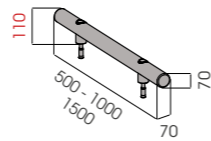

Equipped with accessories

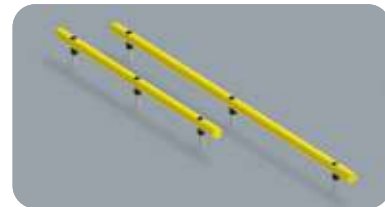

RF 70 2000  
3000

Length 2.000 / 3.000 mm  
Packing unpacked on pallet  
Colour M

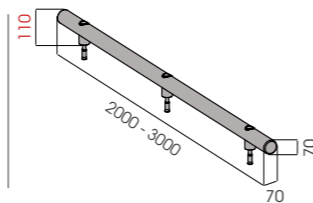

Equipped with accessories

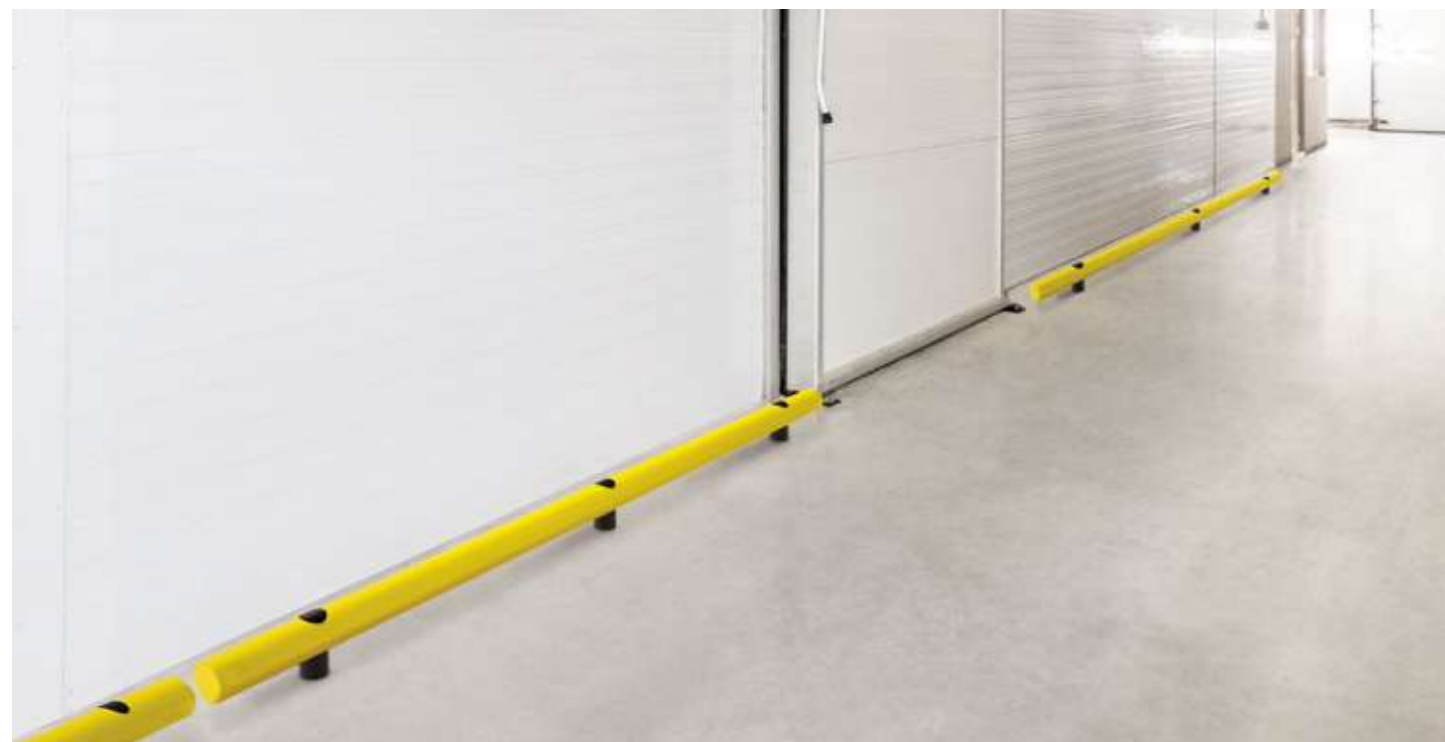

# ROD FLOOR 120



HIGH  
RESISTANCE  
WITH  
RESIN



M20  
STAINLESS STEEL

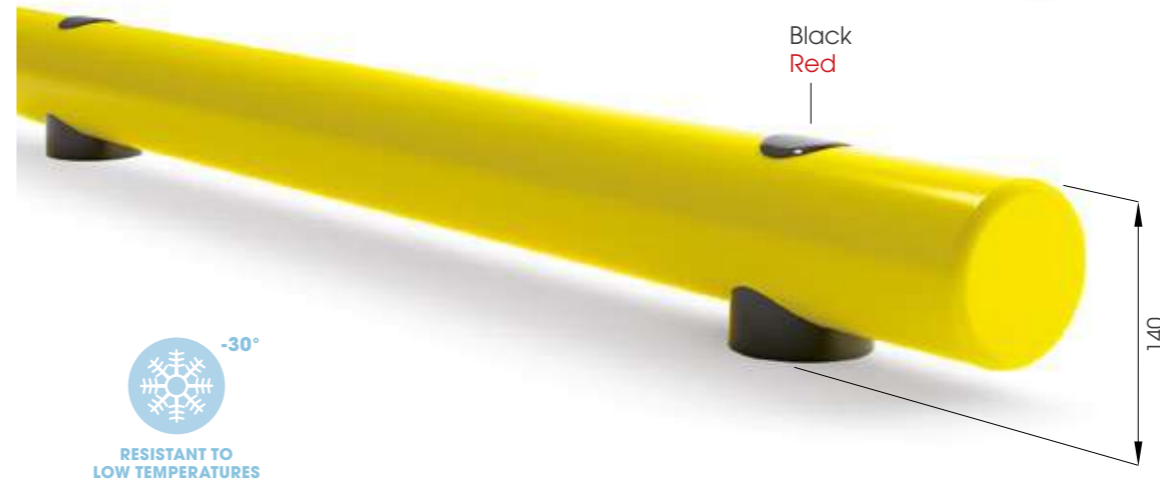

RESISTANT TO  
LOW TEMPERATURES

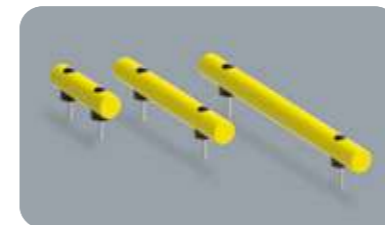

RF 120 500  
1000  
1500

Length 500 / 1000 / 1500 mm  
Packing unpacked on pallet  
Colour M

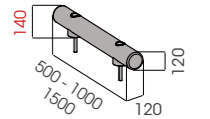

Equipped with accessories



RF 120 2000  
3000

Length 2.000 / 3.000 mm  
Packing unpacked on pallet  
Colour M

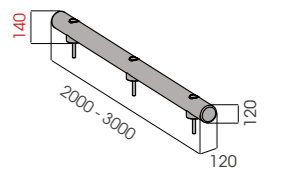

Equipped with accessories

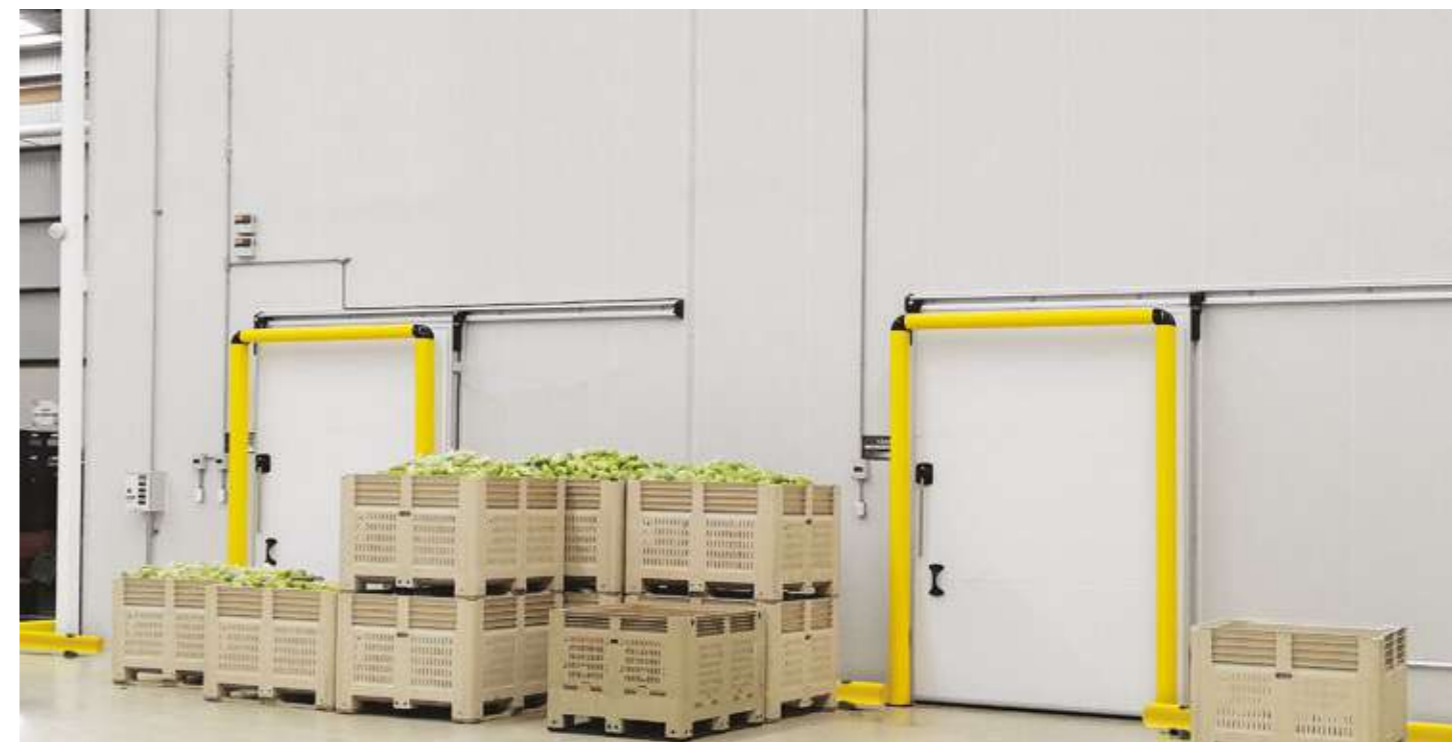

# 05

## PEDESTRIAN SAFETY BARRIERS

A new protection system specific for the protection of pedestrians and resistant to trolleys movements with different load types. Designed by following an innovative technical design that combines speed and simplicity in the steps of installation and cleaning. Available in different lengths.

Sistema di profili antiurto specifico per la protezione delle aree pedonali dai carrelli in movimento con diverse portate di carico. Progettato seguendo un innovativo disegno tecnico che coniuga rapidità e semplicità nelle fasi di installazione e pulizia. Disponibile in diverse lunghezze.

Nouveau système bumper, spécifique pour protéger les zones piétonnes contre les mouvements des charriots. Étudié avec un modern dessin qui regroupe la rapidité et la facilité pendant l'installation et le nettoyage. Disponible en différents longueurs.

Sistema específico de perfiles anti choque para la protección de zonas peatonales de carros en movimiento con diferentes capacidades de carga. Diseñado según un diseño técnico innovador que une velocidad y simplicidad en las fases de instalación y limpieza. Disponible en diferentes longitudes.



### HAND RAIL 90



FAST AND EASY TO INSTALL



M12 GALVANISED STEEL

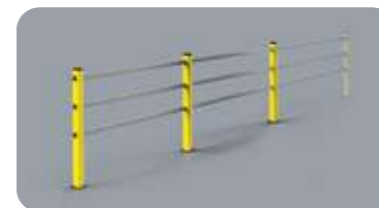

HR 90 1500x1150 MODULAR

Packing Colour **unpacked on pallet** M

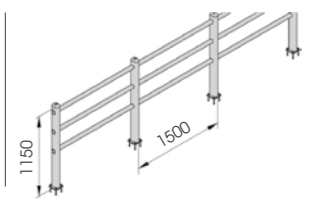

Equipped with accessories

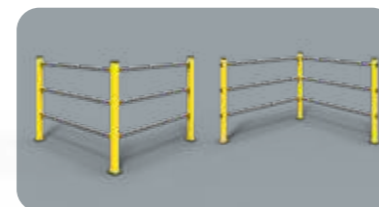

HR 90 1500x1150 CORNER

Packing Colour **unpacked on pallet** M

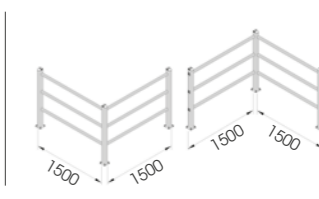

Equipped with accessories



# PEDESTRIAN 90



FAST AND EASY TO INSTALL



M12 GALVANISED STEEL



**PED 90 1500x1150 MODULAR**

Packing Colour **unpacked on pallet**  
B M

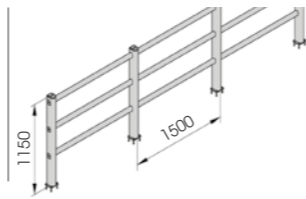

Equipped with accessories



**PED 90 1500x1150 CORNER**

Packing Colour **unpacked on pallet**  
B M

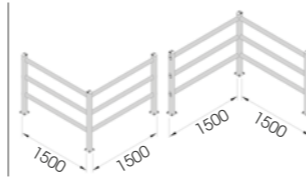

Equipped with accessories



# PEDESTRIAN 150



FAST AND EASY TO INSTALL



M12 GALVANISED STEEL



**PED 150 2000x1150 MODULAR**

Packing Colour **unpacked on pallet**  
B M

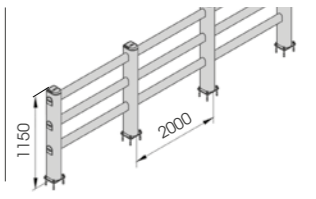

Equipped with accessories

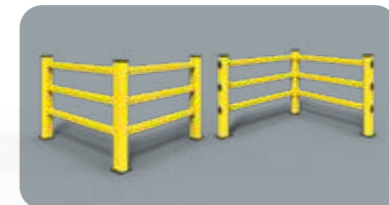

**PED 150 2000x1150 CORNER**

Packing Colour **unpacked on pallet**  
B M

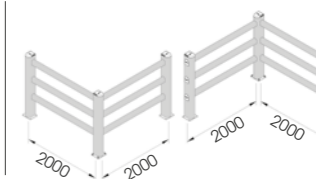

Equipped with accessories



# PEDESTRIAN 90 REINFORCED



M12 GALVANISED STEEL



PED 90 REF MODULAR

Packing Colour **unpacked on pallet**  
 B M

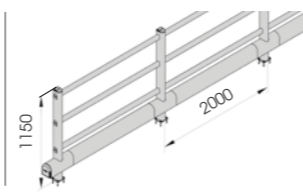

Equipped with accessories



# PEDESTRIAN 150 REINFORCED LINK



M12 GALVANISED STEEL



PED 150 REF LINK

Packing Colour **unpacked on pallet**  
 B M

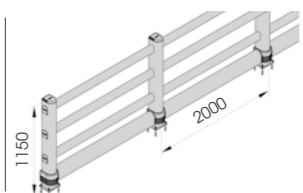

Equipped with accessories



# 06

## DOORS

Safety gate system with different opening possibilities, ideated to be installed on our pedestrian barriers. Designed by following an innovative technical design that combines speed and simplicity in the steps of installation and cleaning. Available in different opening systems.

Sistema di cancelli antiurto ideati per l'installazione nelle nostre barriere di protezione per aree pedonali. Progettati seguendo un innovativo disegno tecnico che coniuga rapidità e semplicità nelle fasi di installazione e pulizia. Disponibili molteplici sistemi di apertura.

Système de portillons résistant aux chocs étudié pour l'installation de nos barrières de protections pour les zones piétons. Portillons conçus suivant un design innovant qui combine rapidité et simplicité pendant le montage et le nettoyage. Différents systèmes d'ouvertures disponibles.

Sistema de puertas antigolpe diseñadas para la instalación de nuestras barreras de protección para áreas peatonales. Diseñado según un diseño técnico innovador que une velocidad y simplicidad en las fases de instalación y limpieza. Están disponibles varios sistemas de apertura.



### FULL FRAME



DIFFERENT SIZES ON REQUEST

FAST AND EASY TO INSTALL



OPTION: WALL FIXING ACCESSORIES

NEW BIGGER PLATES!

M16 STAINLESS STEEL



# DOOR PEDESTRIAN 90

DIFFERENT SIZES ON REQUEST



NEW SWING OPENING

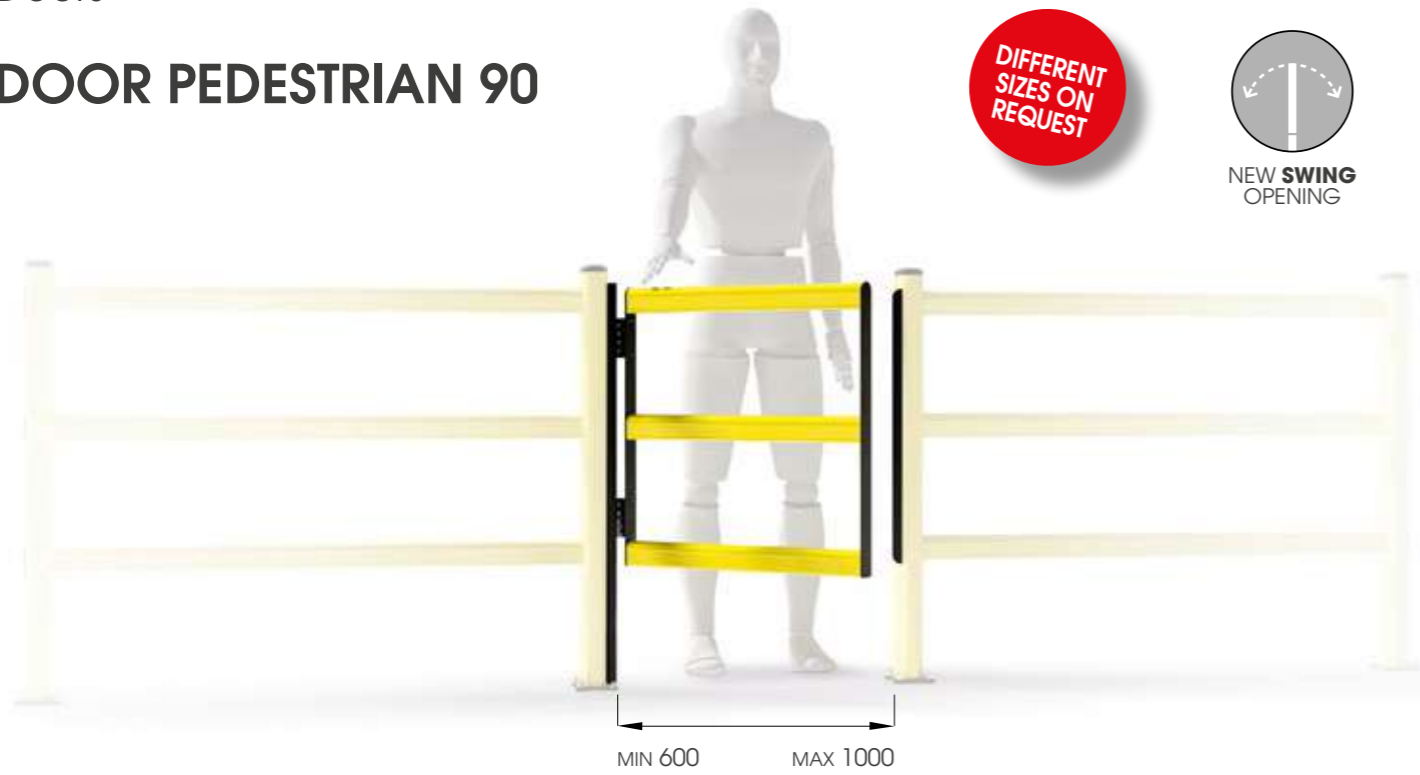

**DP 90 ONE WAY**

Equipped with accessories

Packing Colour **to be defined**



**DP 90 SWING**

Equipped with accessories

Packing Colour **to be defined**

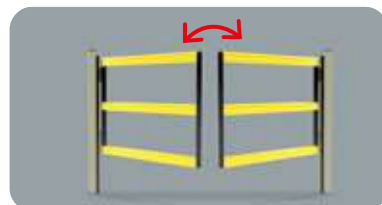
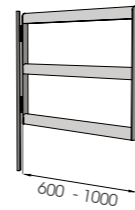

**DP 90 SWING DOUBLE**

Equipped with accessories

Packing Colour **to be defined**

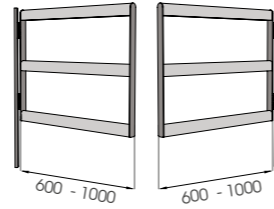

# DOOR PEDESTRIAN 150

DIFFERENT SIZES ON REQUEST



NEW SWING OPENING

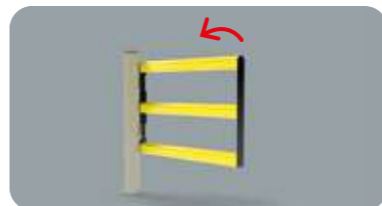

**DP 150 ONE WAY**

Equipped with accessories

Packing Colour **to be defined**

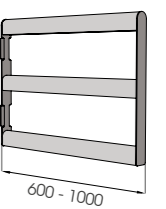

**DP 150 SWING**

Equipped with accessories

Packing Colour **to be defined**

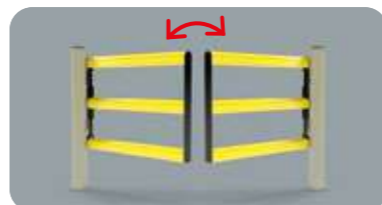
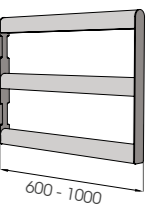

**DP 150 SWING DOUBLE**

Equipped with accessories

Packing Colour **to be defined**

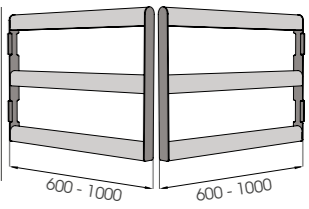

# LIFT GATE 90

DIFFERENT SIZES ON REQUEST

NEW

# LIFT GATE 90 DOUBLE



DOUBLE GATE

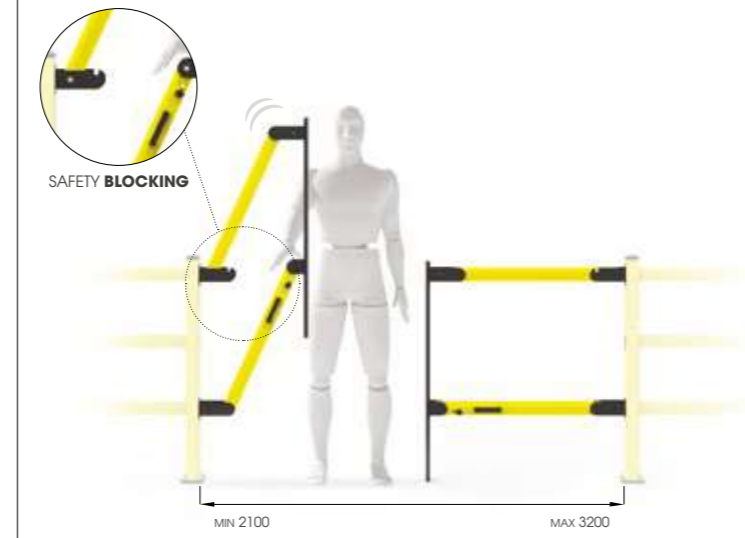
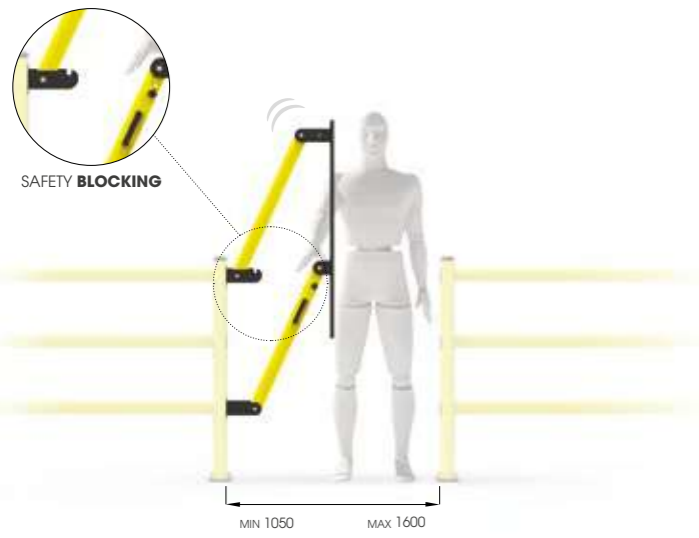

## LIFT GATE 90

Equipped with accessories

Packing Colour **to be defined**

M



## LIFT GATE 90 DOUBLE

Equipped with accessories

Packing Colour **to be defined**

M



# LIFT GATE 150

DIFFERENT SIZES ON REQUEST

NEW

# LIFT GATE 150 DOUBLE



DOUBLE GATE

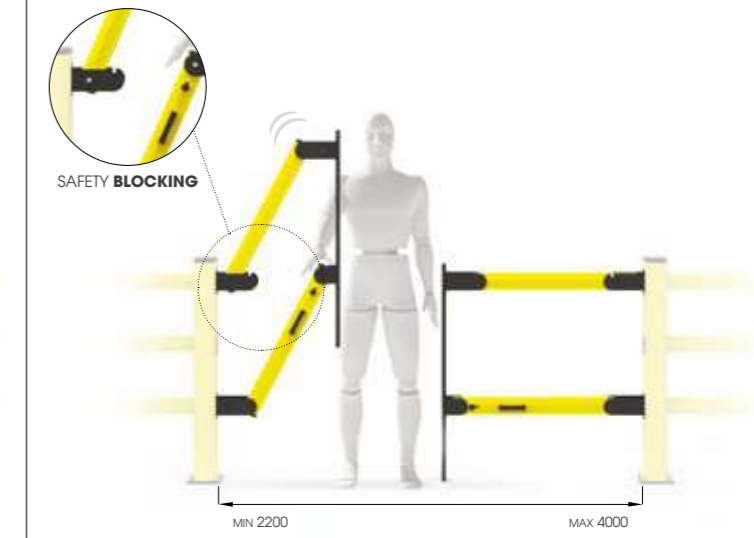
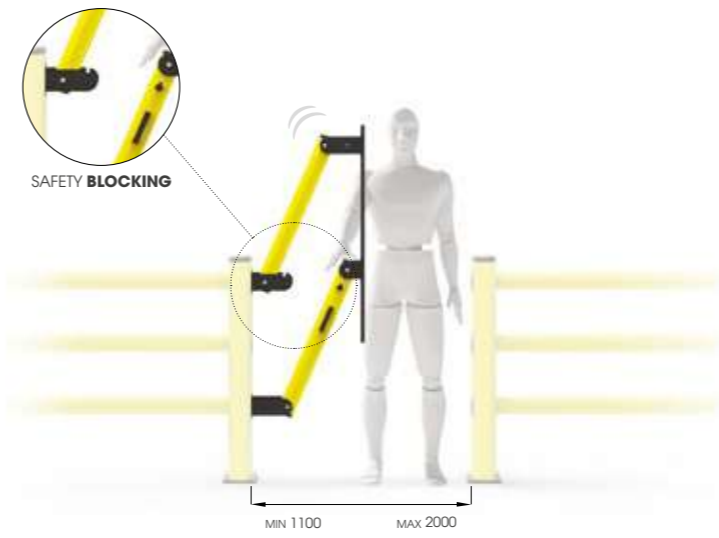

## LIFT GATE 150

Equipped with accessories

Packing Colour **to be defined**

M



## LIFT GATE 150 DOUBLE

Equipped with accessories

Packing Colour **to be defined**

M

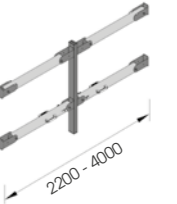



# 07

# LINK

The first adaptable barrier in the world thanks to the new connection system. Rail adjustable height, easy to set up, higher resistance in the most critical points.

Prima barriera al mondo regolabile a piacimento con nuovo sistema di raccordo. Altezza regolabile, facilmente componibili e resistenza potenziata nei punti piu' critici.

Première barrière au monde à modifier aux besoins avec un nouveau système de jonction. Hauteur à changer, facile à assembler et résistance renforcée aux points plus compliqués.

Primera barrera del mundo ajustable según lo necesario con un nuevo sistema de ajuste. Altura ajustable, fácilmente componibles y resistencia potenciada en los puntos más críticos.

**NEW  
PRODUCT**



**ADAPTABLE  
HEIGHT**  
↕  
**ON YOUR  
NEEDS**

## LINK 150/3



Link

**DIFFERENT  
SIZES ON  
REQUEST**



**M12  
GALVANISED STEEL**

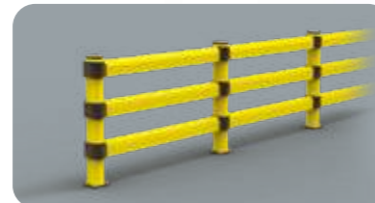

**LINK 150/3**

Packing **unpacked on pallet**  
Colour **M**

Equipped with accessories

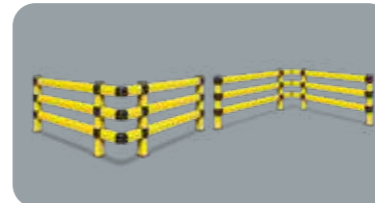
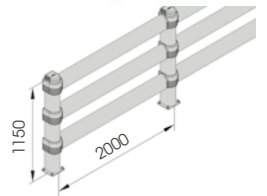

**LINK 150/3  
CORNER**

Packing **unpacked on pallet**  
Colour **M**

Equipped with accessories

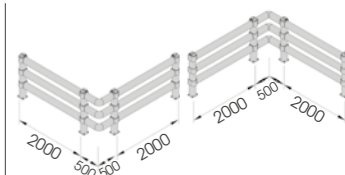

# LINK 150/2



DIFFERENT SIZES ON REQUEST

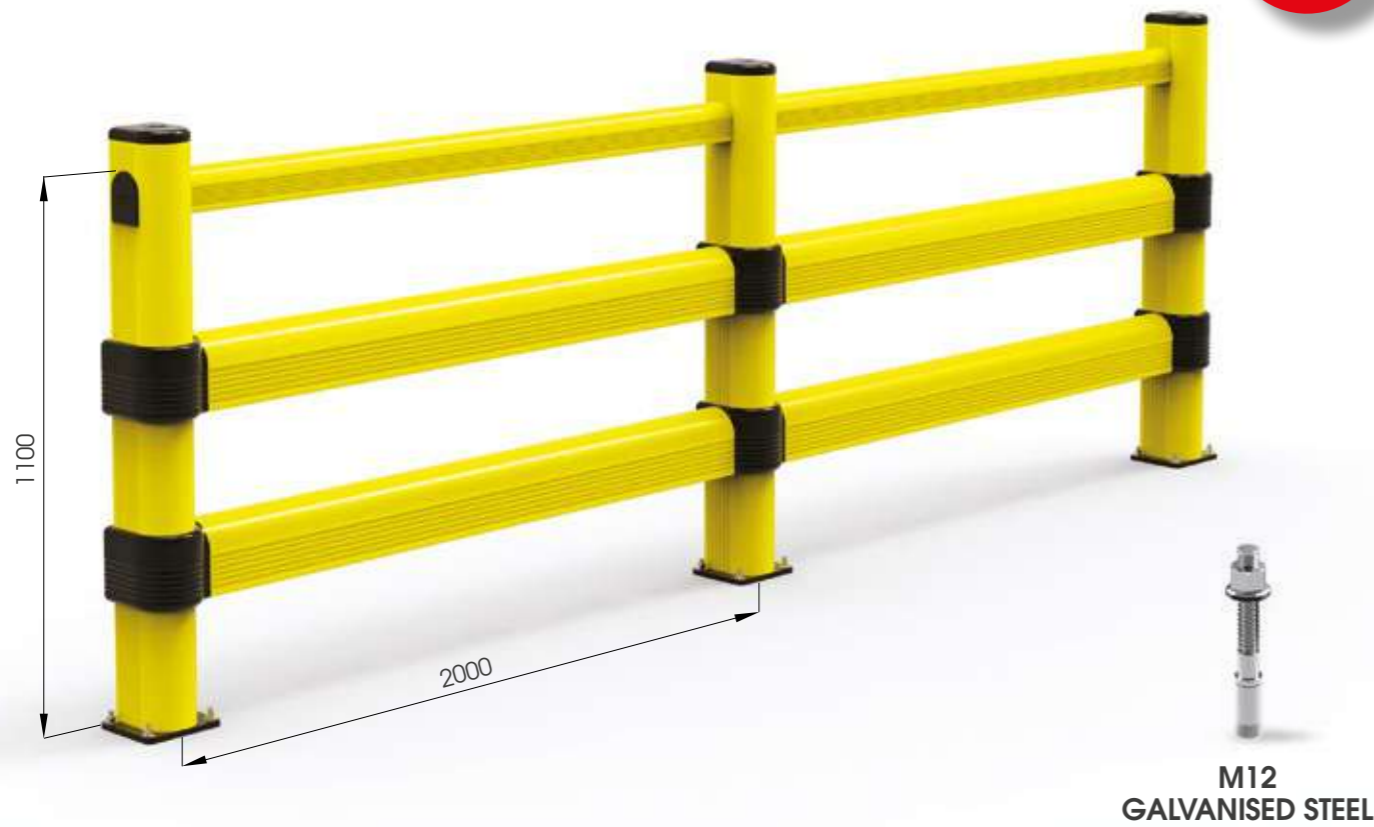

M12 GALVANISED STEEL

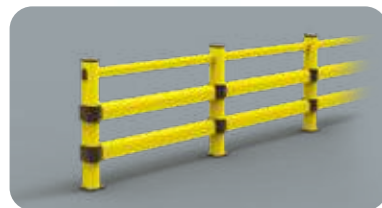

LINK 150/2

Equipped with accessories

Packing Colour **M** unpacked on pallet

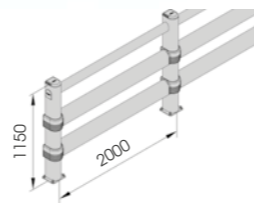

# LINK 150/1



DIFFERENT SIZES ON REQUEST



M12 GALVANISED STEEL



LINK 150/1

Equipped with accessories

Packing Colour **M** unpacked on pallet

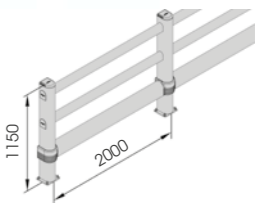

# LINK LM



DIFFERENT SIZES ON REQUEST



M12 GALVANISED STEEL

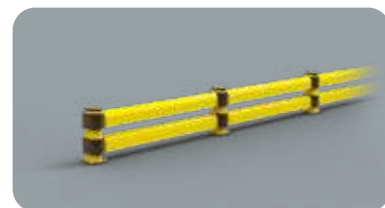

LINK LM 500 800

Equipped with accessories

Packing Colour **M** unpacked on pallet

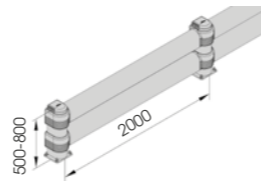

LINK LM CORNER

Equipped with accessories

Packing Colour **M** unpacked on pallet

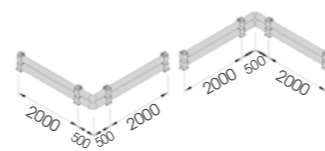

# LINK SINGLE



DIFFERENT SIZES ON REQUEST

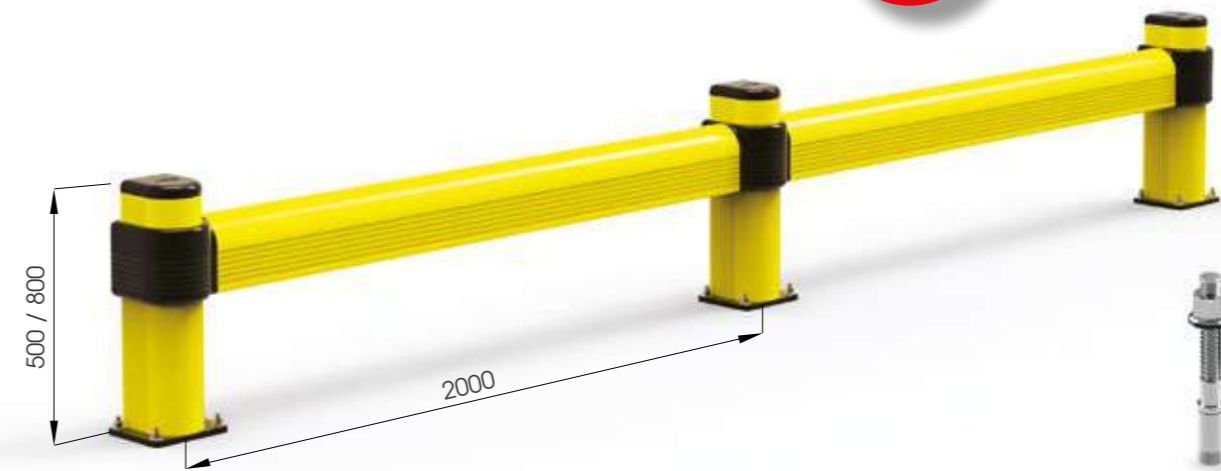

M12 GALVANISED STEEL

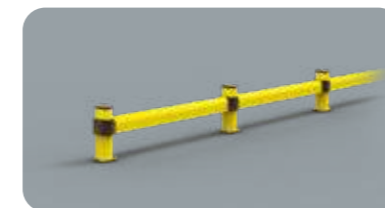

LINK SINGLE 500 800

Equipped with accessories

Packing Colour **M** unpacked on pallet

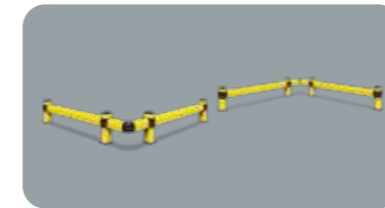
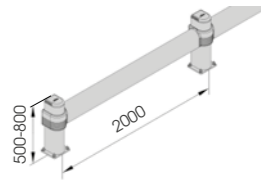

LINK SINGLE CORNER

Equipped with accessories

Packing Colour **M** unpacked on pallet

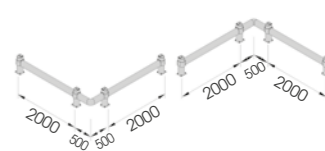

# 08 BFLEX

A new safety protection system with reinforced profile. It is a more flexible and shock-absorber solution. Designed to ensure high safety standards and to resist impacts from heavy loads. Available in many different versions.

Nuovo sistema di protezioni con profilo rinforzato, doppiamente flessibile e assorbente. Progettato e realizzato con un particolare design per garantire alti livelli di sicurezza e resistere all'impatto da carichi pesanti. Disponibile in diverse versioni.

Nouveau système de protection avec profil renforcé, doublement flexible et absorbant. Conçu et produit avec un design particulier pour assurer des niveaux élevés de sécurité et résister à l'impact des charges lourdes. Disponible en plusieurs versions.

Nuevo sistema de protección con perfil reforzado, más flexible y capaz de absorber los impactos. Diseñado para asegurar el entorno laboral y para resistir a los impactos de cargas pesadas. Disponible en diferentes versiones.

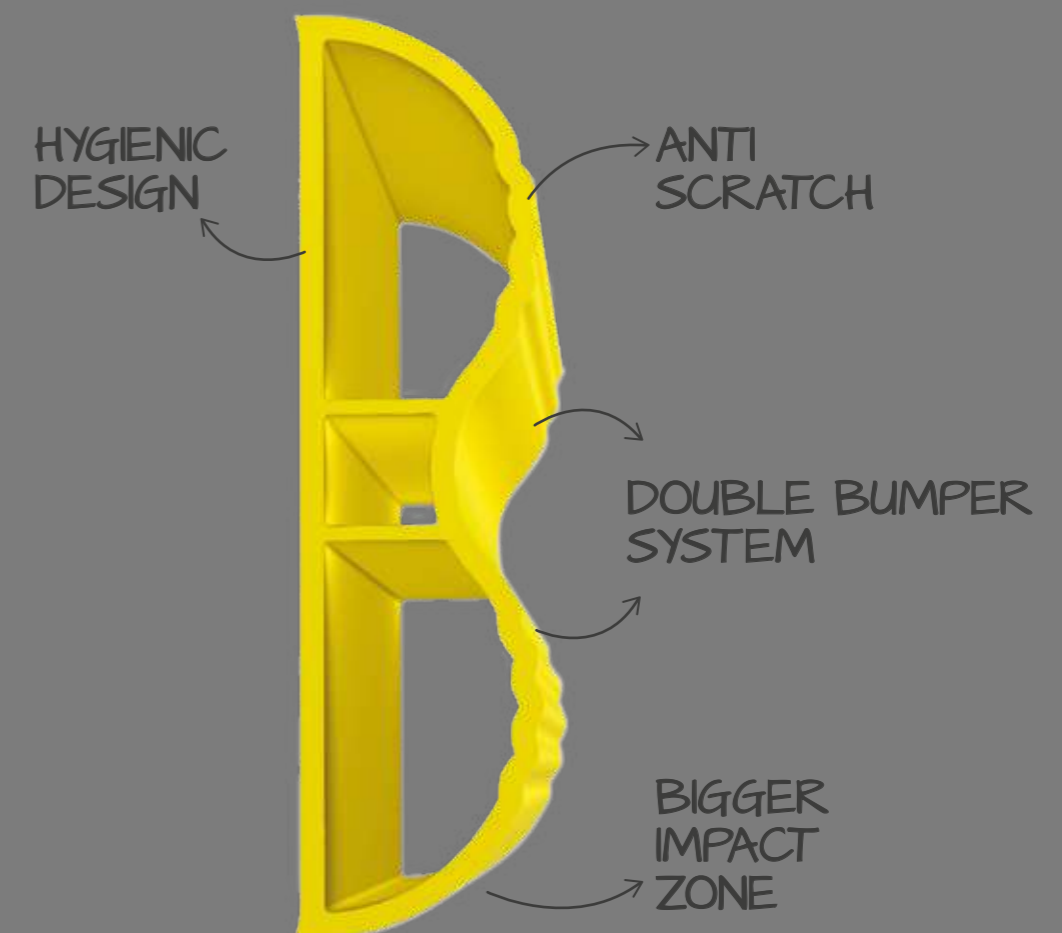

# BFLEX.FRONT/1



M12 GALVANISED STEEL



**BFLEX.FRONT/1 2000x450 MODULAR**

Packing Colour **M** unpacked on pallet

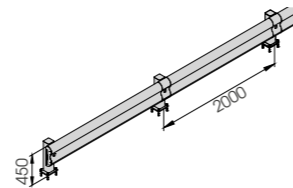

Equipped with accessories



**BFLEX.FRONT/1 1100x450**  
**BFLEX.FRONT/1 2400x450**

Length Packing Colour **M** 1.100 / 2.400 mm unpacked on pallet

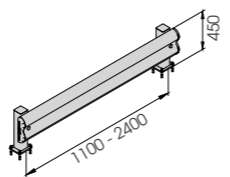

Equipped with accessories



# BFLEX.FRONT/2



M12 GALVANISED STEEL



**BFLEX.FRONT/2 2000x1100 MODULAR**

Packing Colour **M** unpacked on pallet

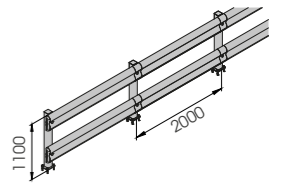

Equipped with accessories



**BFLEX.FRONT/2 1100x1100**  
**BFLEX.FRONT/2 2400x1100**

Length Packing Colour **M** 1.100 / 2.400 mm unpacked on pallet

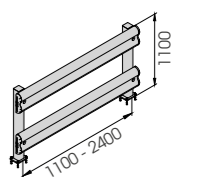

Equipped with accessories



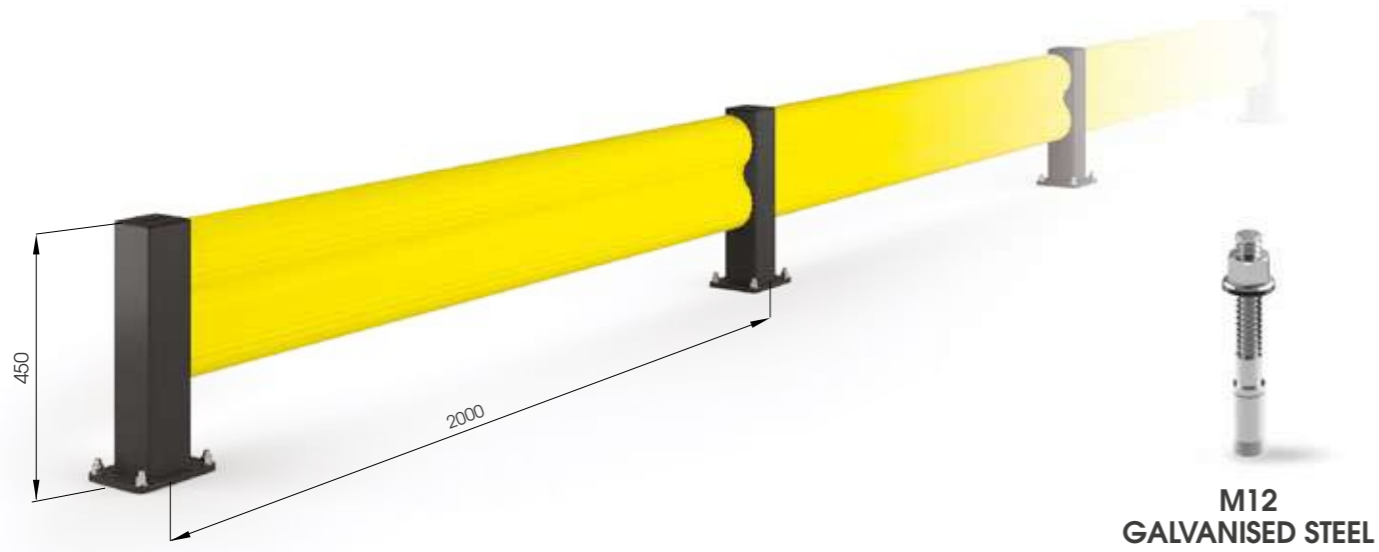

M12 GALVANISED STEEL



**BFLEX.COM/1 2000x450 MODULAR**

Equipped with accessories

Packing Colour **B** **M**

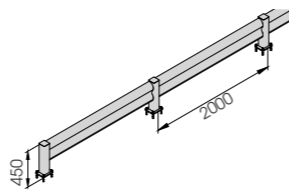

**BFLEX.COM/1 1100x450**  
**BFLEX.COM/1 2400x450**

Equipped with accessories

Length Packing Colour **B** **M**  
1.100 / 2.400 mm  
unpacked on pallet

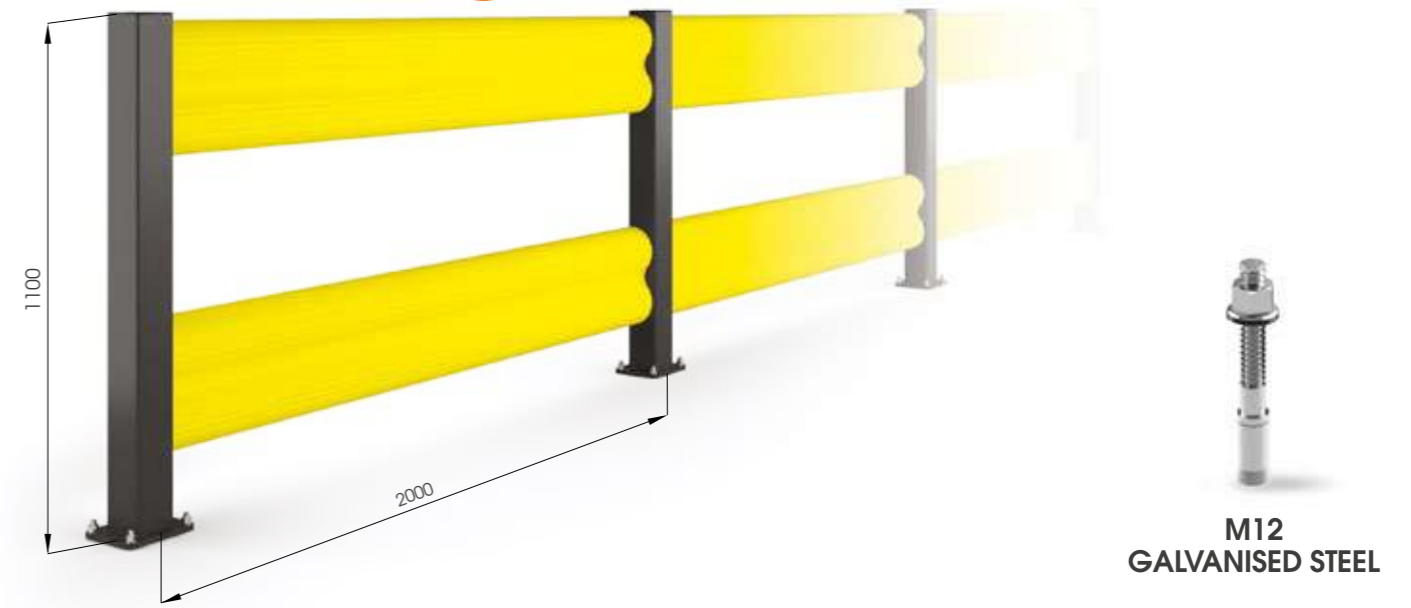
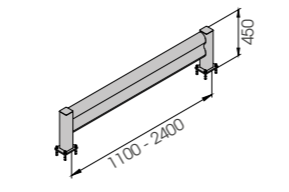

M12 GALVANISED STEEL



**BFLEX.COM/2 2000x1100 MODULAR**

Equipped with accessories

Packing Colour **B** **M**

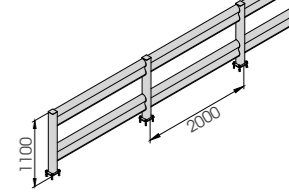

**BFLEX.COM/2 1100x1100**  
**BFLEX.COM/2 2400x1100**

Equipped with accessories

Length Packing Colour **B** **M**  
1.100 / 2.400 mm  
unpacked on pallet

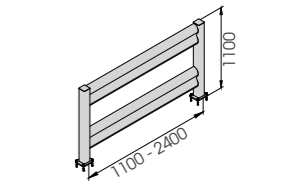

NOW READY  
**NEW OPTIONS FOR**  
OUR **SAFETY BARRIERS**  
AND **RACK PROTECTORS**



AVAILABLE FOR:  
**LINK / SM / LM / FENCE**  
**HR 90 / PED 90 / PED 150**



# 09

## COLUMN PROTECTION

A new bumper system specific for the protection of the columns resistant against trolleys movements and for different load types. Designed by following an innovative technical design that combines speed and simplicity in the steps of installation and cleaning. Available in different heights and fixing systems.



Sistema di profili specifico per la protezione delle colonne dai carrelli in movimento di varie portate. Progettato seguendo un innovativo disegno tecnico che coniuga rapidità e semplicità nella fasi di installazione e pulizia. Disponibile in diverse altezze e tipologie di fissaggio.

Nouveau système bumper, spécifique pour protéger les poteaux contre les mouvements des chariots. Étudié avec un modern dessin qui regroupe la rapidité et la facilité pendant l'installation et le nettoyage. Disponible en différents hauteurs et différents fixations.

Sistema de perfiles específico para la protección de las columnas de los carros en movimiento de diferentes capacidades. Diseñado según un innovador diseño técnico que une velocidad y simplicidad en las fases de instalación y limpieza. Disponible en diferentes alturas y tipos de fijación.



- REMOVABLE
- NO SCRATCHES
- VERY SOLID AND SLIM DESIGN
- NO FIXING IS REQUIRED



# COLUMN PROTECTION 90



DIFFERENT SIZES ON REQUEST

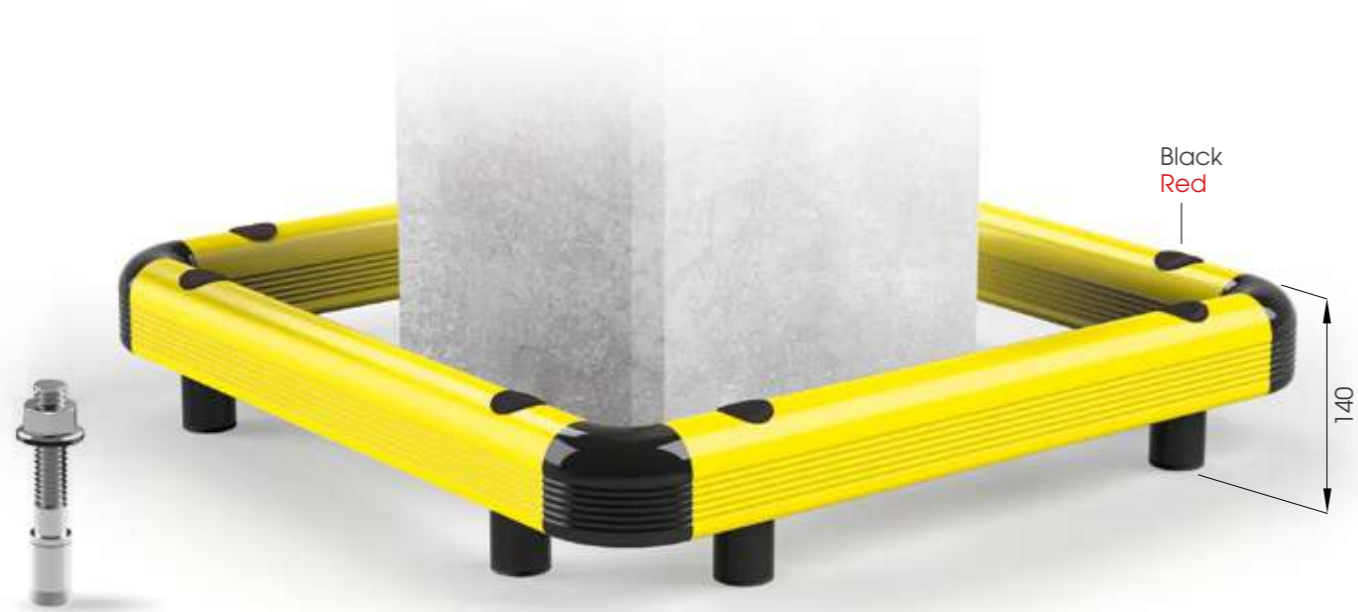

M16  
STAINLESS STEEL



**COPRO 90** 500x500  
600x600  
700x700

Packing Colour **M**  
unpacked on pallet

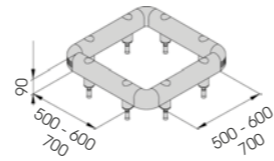

Equipped with accessories



# COLUMN PROTECTION 150



DIFFERENT SIZES ON REQUEST

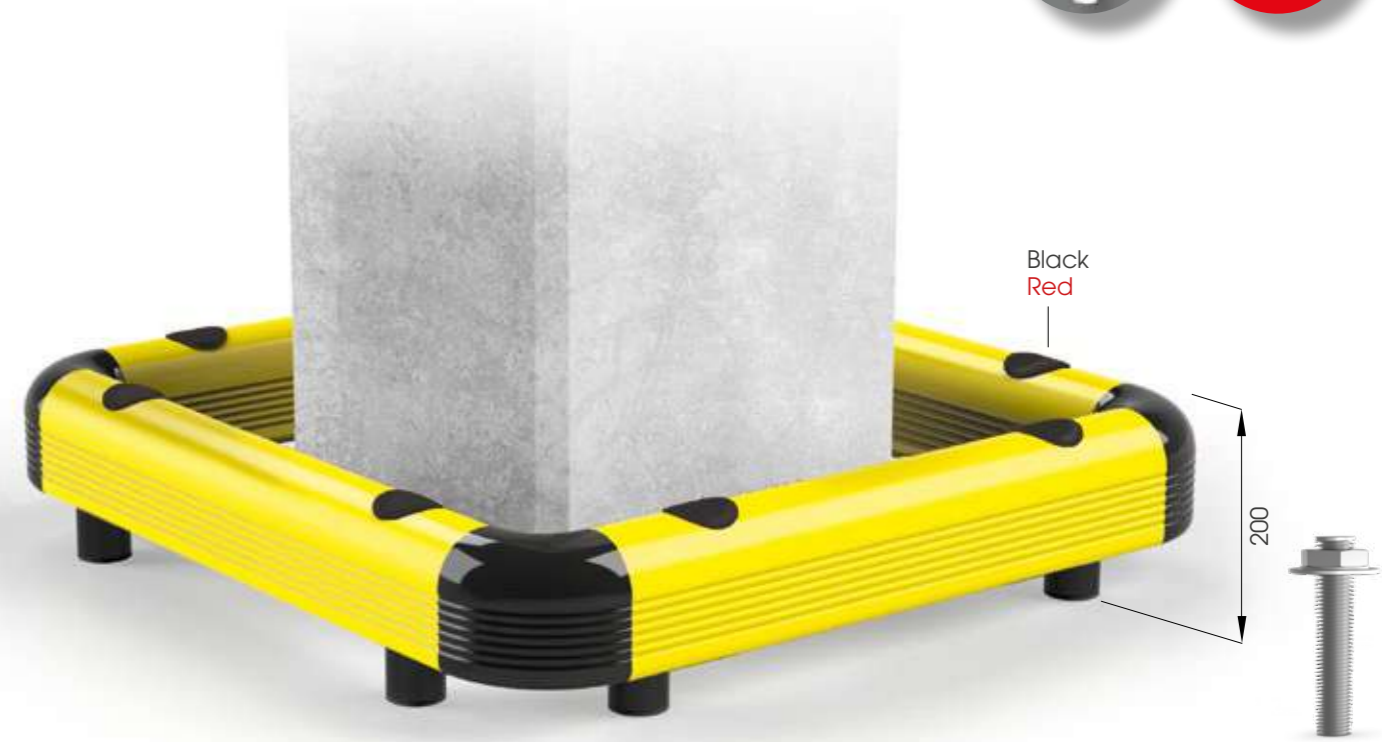

M20  
STAINLESS STEEL



**COPRO 150** 500x500  
600x600  
700x700

Packing Colour **M**  
unpacked on pallet

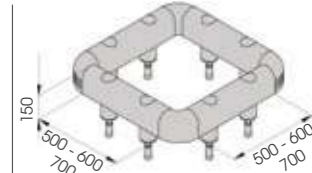

Equipped with accessories



# HUG TOWER

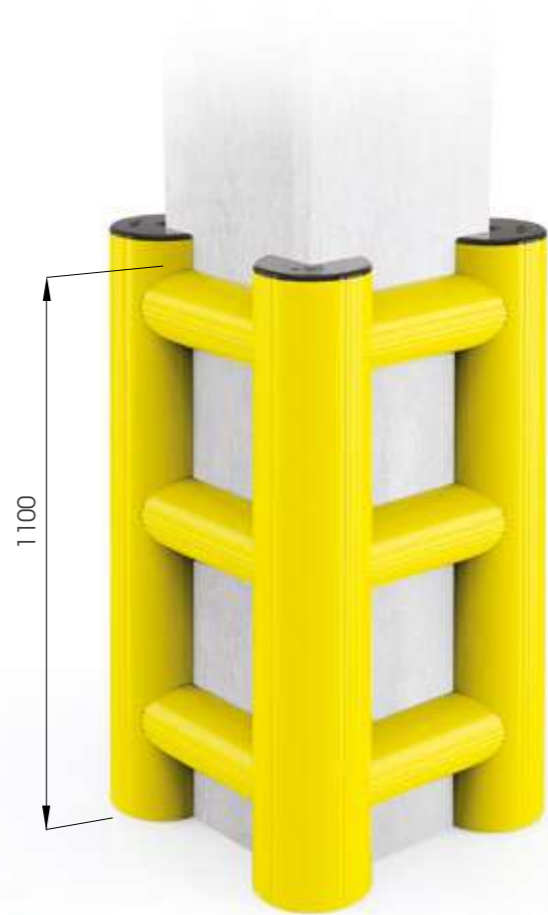

DIFFERENT SIZED AND HEIGHT ON REQUEST

COMPACT



NO HOLES ON THE FLOOR AND COLUMN!

CHOOSE THE HEIGHT YOU NEED! UP TO 5 RAILS

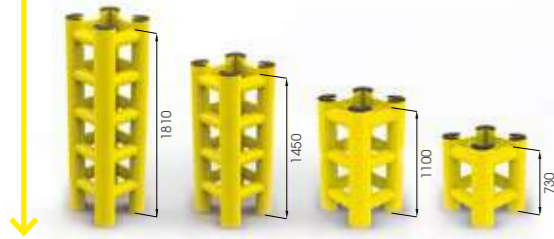

**HUG TOWER** 500x500  
600x600  
700x700

Packing Colour **to be defined**  
M

Equipped with accessories

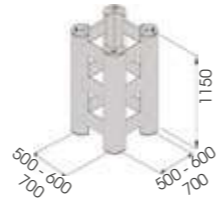

# TOWER PROTECTION



DIFFERENT SIZES ON REQUEST



M12 GALVANISED STEEL



**TOWER** 500x500  
600x600  
700x700

Packing Colour **to be defined**  
M

Equipped with accessories

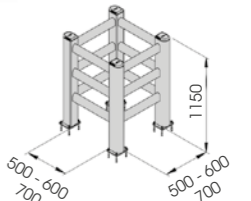

# 10

## LOADING BAYS PROTECTIONS

Loading bays protections are shock-proof solutions which are set up near loading doors. They avoid possible slipping, falling and flipping of moving vehicles near open and unmanned loading bays.

Sistema di protezione antiurto installato in prossimità delle porte di carico. Permettono di evitare situazioni ad alto rischio di scivolamento, caduta e ribaltamento dei mezzi in movimento in presenza di baie di carico aperte e non presidiate.

Système de protection contre les chocs installé près des portes de chargement. Ils permettent d'éviter des situations en raison du risque élevé de glissement, de chute et de basculement des véhicules en mouvement en présence de quais de chargement ouverts et sans surveillance.

La protección de muelles de carga es un sistema anticolidión que está cerca de las puertas de carga. Evitan los riesgos de deslizamiento, caída y derrocamiento los vehículos en movimiento cuando están cerca de los muelles de carga abiertos y no vigilados.



### DOCK GATE



**DOCK GATE L** 2400-2500

Packing Colour **to be defined** M

Equipped with accessories

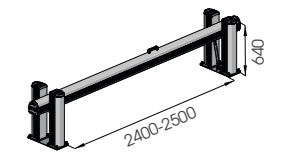

**DOCK GATE XL** 2500-3000

Packing Colour **to be defined** M

Equipped with accessories

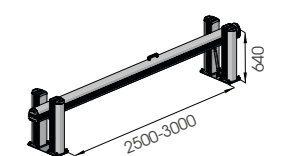

# CORNER PROTECTION

Designed to protect pillars and columns or external corners of walls and panels.

Realizzato per proteggere pilastri e colonne o angoli esterni di muri e pannelli.

Étudié pour protéger les poteaux et les colonnes ou les angles extérieurs de murs et de panneaux.

Realizado para proteger pilares y columnas o esquinas exteriores de paredes y paneles.

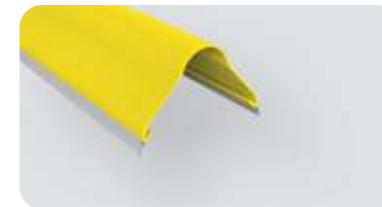

CP 100

Length 4.000 mm  
Packing 10 pz / box  
Colour B M E F  
Length 2.000 mm  
Packing 2 pz / bag  
Colour M

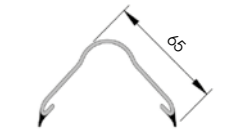

CPF 100

Length 4.000 mm  
Packing 10 pz / bag  
Length 2.000 mm  
Packing 2 pz / bag

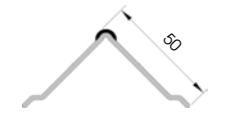

CPT 100

Packing 40 pz / box  
Colour B E F

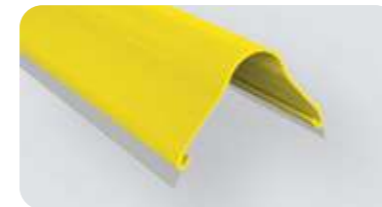
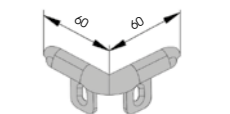

CP 200

Length 4.000 mm  
Packing 2 pz / bag  
Colour B M E  
Length 2.000 mm  
Packing 2 pz / bag  
Colour M



CPF 200

Length 2.000 / 4.000 mm  
Packing 2 pz / bag

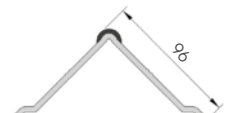

CPT 200

Packing 20 pz box  
Colour B E

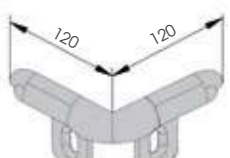

# 12 KERB

A large size protection system, ideal for walls and panels. Easy to install and clean. Fully equipped with corner caps and buttons.

Sistema di protezione di grandi dimensioni, ideale per muri e pannelli. Facile da installare e pulire. Completo di angolari e tappi.

Système de protection de grands dimensions, idéal pour les murs et les panneaux. Facile à installer et à nettoyer. Complété de bouchons d'angles et d'embouts.

Sistema de protección de grande dimensión, ideal para paredes y paneles. Fácil de instalar y limpiar. Completo de esquinas y tapas.

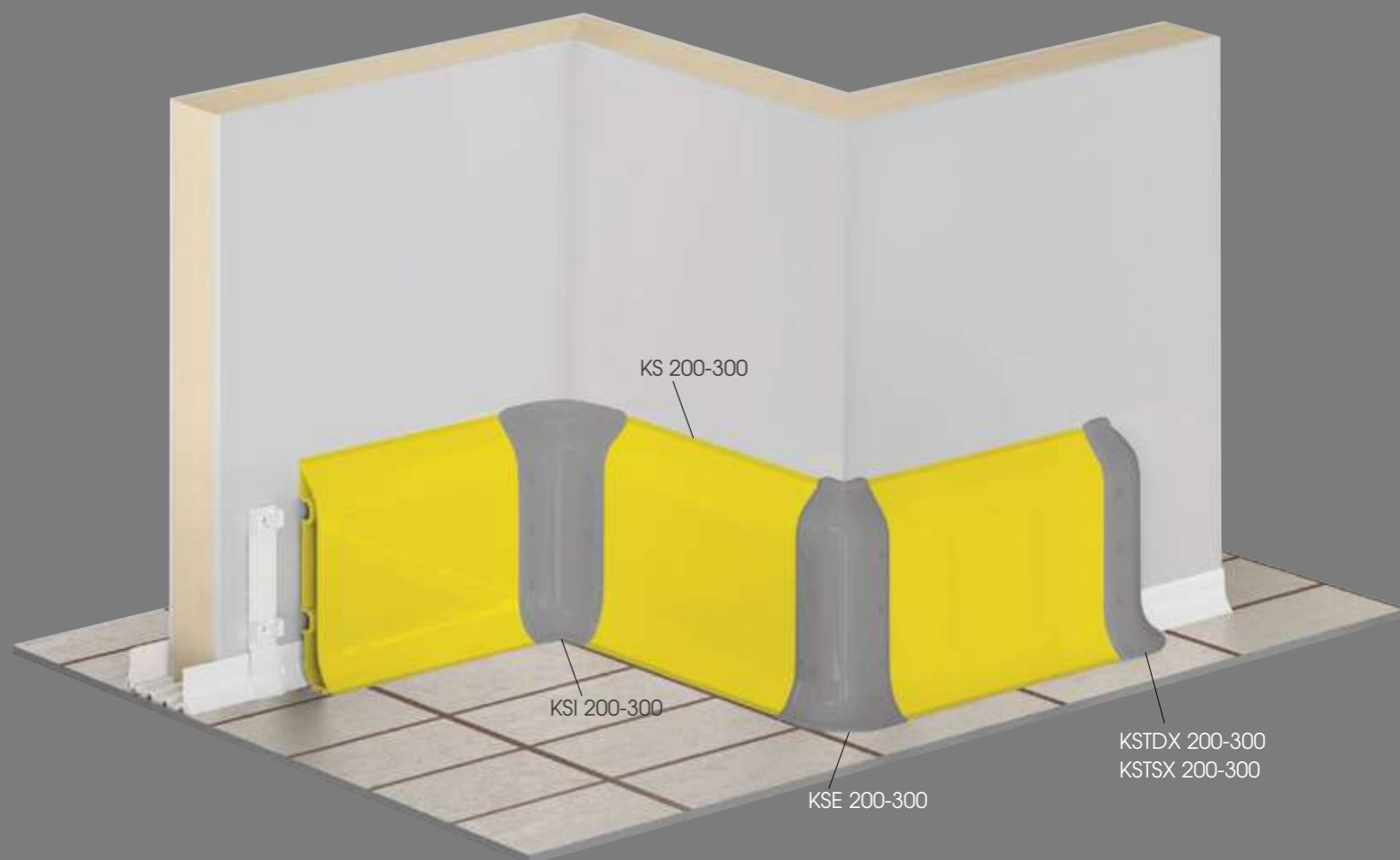



**KS 200**

Length **4.000 mm**  
Packing **3 pz / box**  
Colour **B M E**

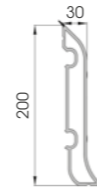

**KEPF 200**

To install with TB14

Packing **50 pz / box**  
Colour **K**



**KSJ 200**

To install with TB14 / TF14

Packing **20 pz / box**  
Colour **B E**

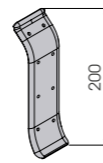

**KSI 200**

To install with TB14 / TF14

Packing **20 pz / box**  
Colour **B E**

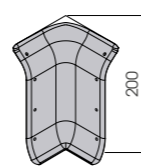

**KSE 200**

To install with TB14 / TF14

Packing **20 pz / box**  
Colour **B E**

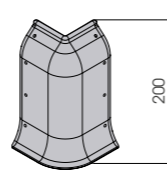

**KSTD/SX 200**

To install with TB14 / TF14

Packing **20 pz / box**  
Colour **B E**

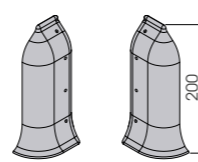

**KSJ 200 LT**



Packing **to be defined**  
Colour **K**

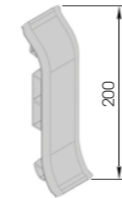

**FLEXIBLE JOINT**

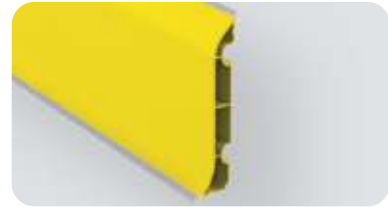

**KS 300**

Length **4.000 mm**  
Packing **1 pz**  
Colour **M E**

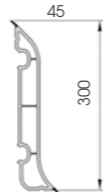

**KEPF 300**

To install with TB20

Packing **40 pz / box**

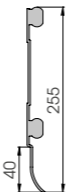

**KSJ 300**

To install with TB20 / TF20

Packing **10 pz / box**  
Colour **B E**

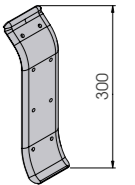

**KSI 300**

To install with TB20 / TF20

Packing **10 pz / box**  
Colour **B E**

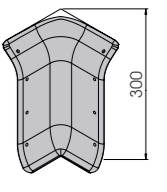

**KSE 300**

To install with TB20 / TF20

Packing **10 pz / box**  
Colour **B E**

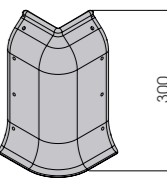

**KSTD/SX 300**

To install with TB20 / TF20

Packing **10 pz / box**  
Colour **B E**

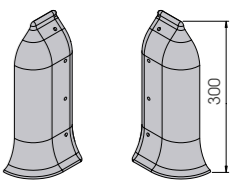

# 13

## WALL PROTECTION

New bumper without guides. Thanks to its big size and resistance it is ideal for protection of industrial spaces. Fixed caps with hidden screws covered by specific buttons.

Nuovo profilo antiurto senza guida. La sua ampiezza e resistenza lo rende ideale per la protezione di ambienti industriali. Terminali fissati con viti nascoste da appositi bottoni.

Nouveau profilé anti-choc sans besoin d'une base à fixer. Sa mesure large et sa résistance en font le profilé parfait pour la protection des espaces industriels. Embouts fixés avec des vis cachées grâce à des bouchons spécifiques.

Nuevo perfil antigolpe sin guía. Su amplitud y resistencia lo hacen ideal para la protección de entornos industriales. Terminales fijados con tornillos ocultos por botones especiales.



### Wall Protection



**WP 100**

Length **4.000 mm**  
Packing **8 pz / box**  
Colour **B E F**

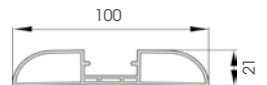

**WP 150**

Length **4.000 mm**  
Packing **4 pz / box**  
Colour **B M E**

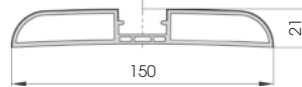

**WPC**

To install with WP 100 / WP 150

Length **4.000 mm**  
Packing **16 pz / box**  
Colour **A B M D E F G H**

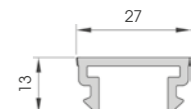

**WPT 100**

To install with TM5

Packing **50 pz / box**  
Colour **B E F**

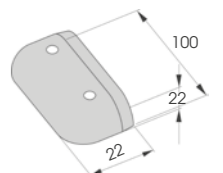

**WPA 100**

To install with TS9

Packing **20 pz / box**  
Colour **B E**

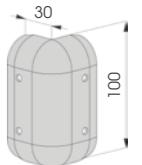

**WPT 150**

To install with TM5

Packing **50 pz / box**  
Colour **B E**

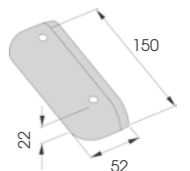

**WPA 150**

To install with TS9

Packing **20 pz / box**  
Colour **B E**

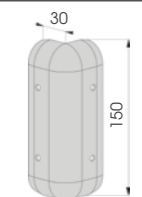

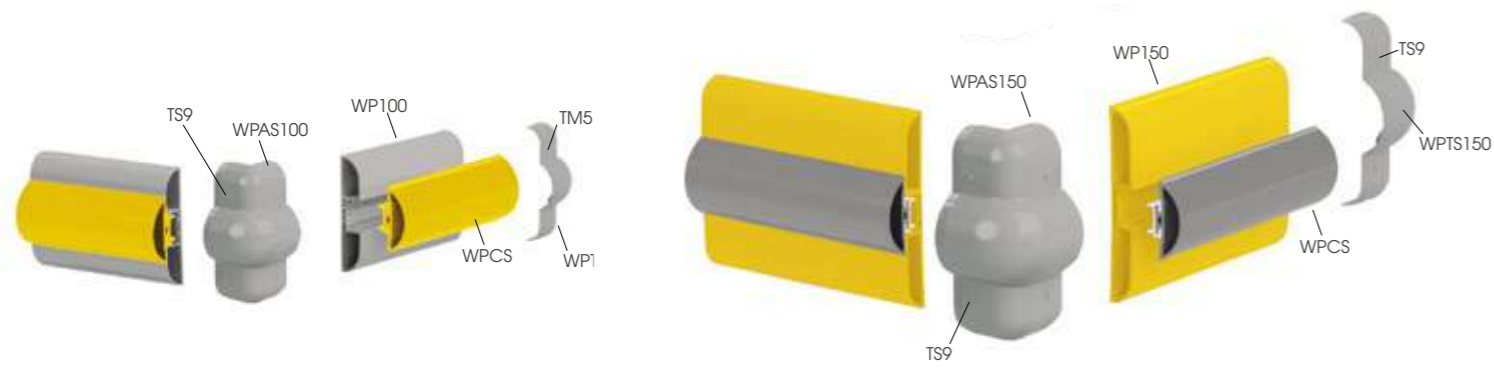

**WP 100**

Length **4.000 mm**  
Packing **8 pz / box**  
Colour **B E F**

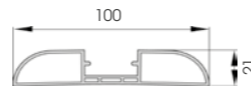

**WP 150**

Length **4.000 mm**  
Packing **4 pz / box**  
Colour **B M E**

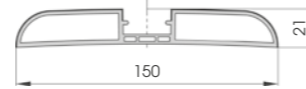

**WPCS**

To install with WP 100 / WP 150

Length **4.000 mm**  
Packing **8 pz / box**  
Colour **A B M D E F G H I**



**WPTS 100**

To install with TS9

Packing **20 pz / box**  
Colour **B E**

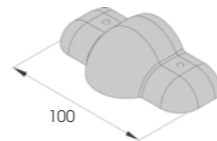

**WPAS 100**

To install with TS9

Packing **20 pz / box**  
Colour **B E**

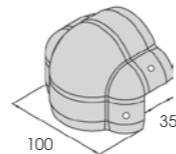

**WPTS 150**

To install with TS9

Packing **20 pz / box**  
Colour **B E**

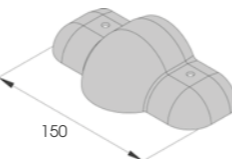

**WPAS 150**

To install with TS9

Packing **20 pz / box**  
Colour **B E**

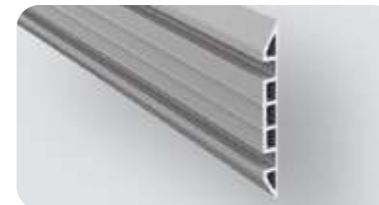
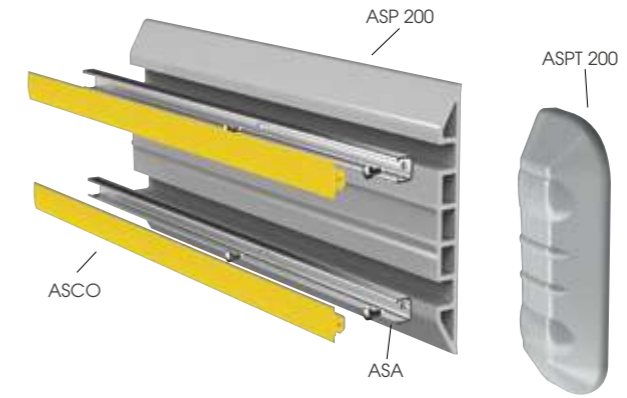
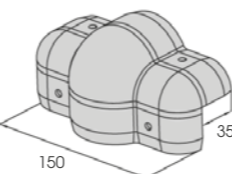

**ASP 200**

**SOFT**

Length **4.000 mm**  
Packing **2 pz / box**  
Colour **B M**

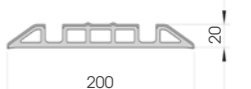

**ASPT 200**

**SOFT**

Packing **10 pz / box**  
Colour **B D**

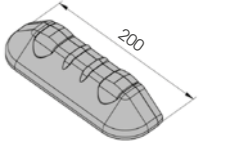

**ASA**

Material **aluminium**  
Length **4.000 mm**  
Packing **8 pz / bundle**



**ASCO**

**SOFT**

Packing **2 pz / box**  
L = **32.000 mm**  
Colour **A B M D E**

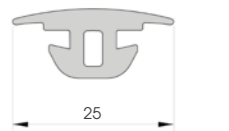





**WALL HUG** 1000  
2000  
3000  
4000

Length 1000/2000/3000/4000  
Packing unpacked  
Colour M

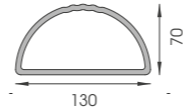

**WALL BFLEX** 1000  
2000  
3000  
4000

Length 1000/2000/3000/4000  
Packing unpacked  
Colour M

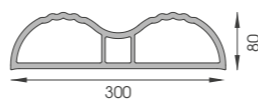

# NEWS



**LOFT BARRIER**  
WORLD'S FIRST FIXED PROTECTION  
SYSTEM FOR SUSPENDED AREAS

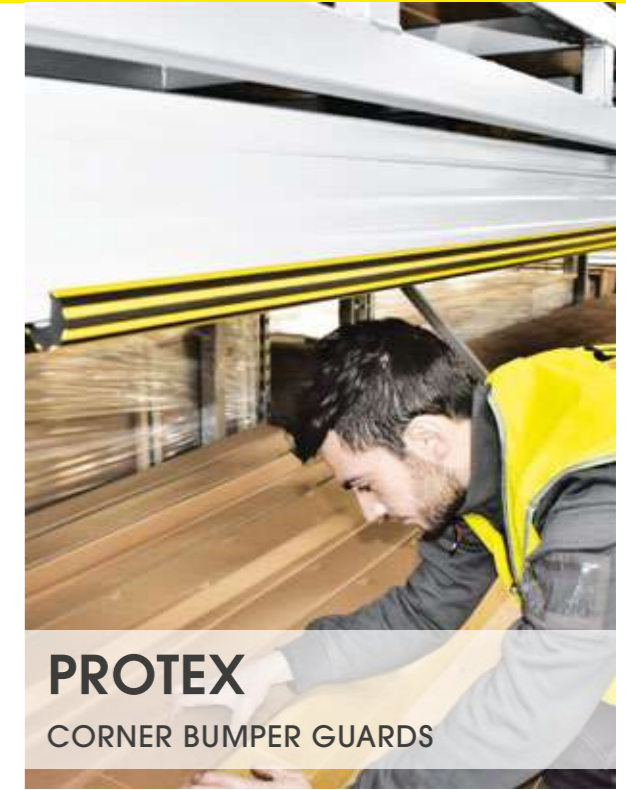

**PROTEX**  
CORNER BUMPER GUARDS



**FENCE LINK**  
THE ADAPTABLE STRONGEST  
SOLUTION FOR RACK-ENDS



Now available  
**CUSTOMISED RACK PROTECTOR,**  
new version of rack protector  
processed upon request!

**CUSTOMISED RACK PROTECTOR**

## Fixing accessories



**TM5**  
Hole required  $\varnothing$  8.5  
Neutral polyethylene. 100/500 Pcs. / bag.

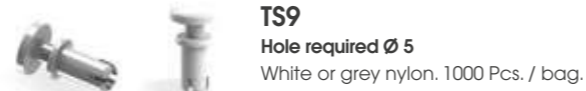

**TS9**  
Hole required  $\varnothing$  5  
White or grey nylon. 1000 Pcs. / bag.



**TB14**  
Hole required  $\varnothing$  4  
Steel / aluminium, white. 500 Pcs. / box.

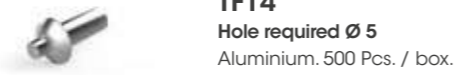

**TF14**  
Hole required  $\varnothing$  5  
Aluminium. 500 Pcs. / box.



**TB20**  
Hole required  $\varnothing$  5  
Steel / aluminium. 500 Pcs. / box.

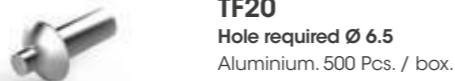

**TF20**  
Hole required  $\varnothing$  6.5  
Aluminium. 500 Pcs. / box.

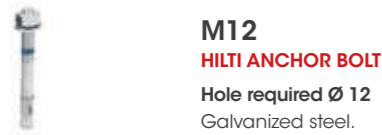

**M12**  
**HILTI ANCHOR BOLT**  
Hole required  $\varnothing$  12  
Galvanized steel.

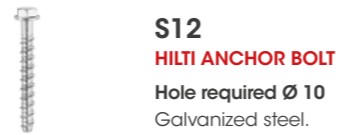

**S12**  
**HILTI ANCHOR BOLT**  
Hole required  $\varnothing$  10  
Galvanized steel.

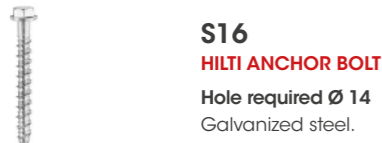

**S16**  
**HILTI ANCHOR BOLT**  
Hole required  $\varnothing$  14  
Galvanized steel.



**B12**  
**HILTI INSERT**  
Hole required  $\varnothing$  18  
Galvanized steel.

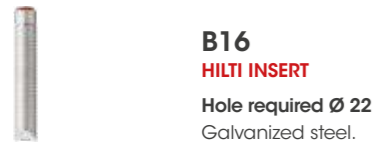

**B16**  
**HILTI INSERT**  
Hole required  $\varnothing$  22  
Galvanized steel.

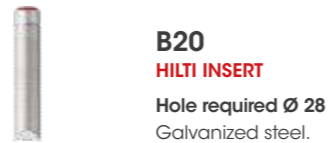

**B20**  
**HILTI INSERT**  
Hole required  $\varnothing$  28  
Galvanized steel.

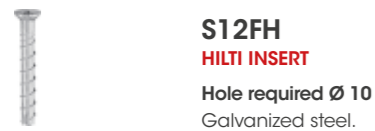

**S12FH**  
**HILTI INSERT**  
Hole required  $\varnothing$  10  
Galvanized steel.

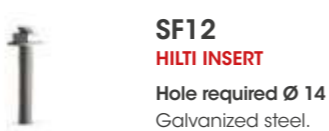

**SF12**  
**HILTI INSERT**  
Hole required  $\varnothing$  14  
Galvanized steel.

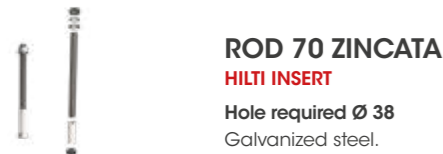

**ROD 70 ZINCATA**  
**HILTI INSERT**  
Hole required  $\varnothing$  38  
Galvanized steel.

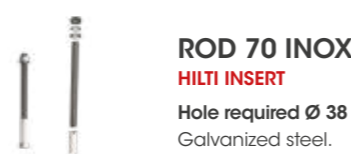

**ROD 70 INOX**  
**HILTI INSERT**  
Hole required  $\varnothing$  38  
Galvanized steel.

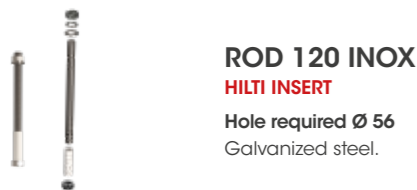

**ROD 120 INOX**  
**HILTI INSERT**  
Hole required  $\varnothing$  56  
Galvanized steel.

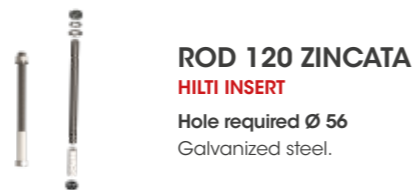

**ROD 120 ZINCATA**  
**HILTI INSERT**  
Hole required  $\varnothing$  56  
Galvanized steel.

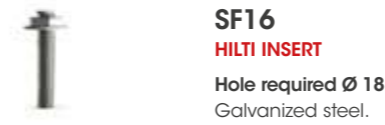

**SF16**  
**HILTI INSERT**  
Hole required  $\varnothing$  18  
Galvanized steel.



**M16**  
**HILTI INSERT**  
Hole required  $\varnothing$  16  
Galvanized steel.



**M16 INOX**  
**HILTI INSERT**  
Hole required  $\varnothing$  16  
Galvanized steel.



**FR**  
**HILTI CHEMICAL ANCHOR**  
300 ML

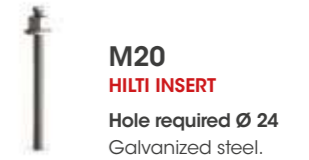

**M20**  
**HILTI INSERT**  
Hole required  $\varnothing$  24  
Galvanized steel.



**FIX P90**  
Galvanized steel and painted.



**COVER 90 RE**  
Galvanized steel and painted. 8 Pcs. / box.



**FIX 90 INOX**  
Stainless steel.



**FIX P150**  
Galvanized steel and painted.



**COVER 150 RE**  
Galvanized steel and painted.



**FIX P150 INOX**  
Stainless steel.



**FIX P150 FH**  
Galvanized steel and painted.



**FULL FRAME BASE**  
Galvanized steel and painted.

## Colours





SOME OF OUR REFERENCES



THE WORLD'S TOP **LOGISTICS**  
PROFESSIONALS CHOOSE OUR  
**QUALITY MADE IN ITALY**



# OUR INSTALLATION



# OUR INSTALLATION



## MPM states that:

The safety coefficient and consequent use of the product requires preliminary screening by a designer who will necessarily have to take account of the actual installation conditions, considering that instructions contained in catalogues, orders, transport documents, invoices or any other documentation showing the product characteristics, should not be considered suitable to compensate for any lack of design or technical testing required for installation of the product.

In any case, it is necessary to comply with the appropriate assembling and installation instructions as defined in the technical catalogue on corporate websites ([www.mpmprotections.com](http://www.mpmprotections.com)). MPM will accept no liability for the use of profiles in situations that have not been preceded by the above-mentioned checks.

Impact forces indicated in the brochure, or in other documents, refer to laboratory tests and cannot take account for consequences determined by installation modes or peculiarities of the place where the products are installed (in an operational environment vehicle type, speed and mass, routes, angles of impact, ground and anchorage are variable and uncontrolled conditions that no test can replicate); the data refers to an intact product that can be affected by alterations from incorrect maintenance and old age, as well as the methods and characteristics of installation (with specific reference to floor-mounted products like the latter); the weight, dimensions, colours and characteristics of the material refer to the sample and the conformity with the latter of the product supplied will be subject to normal production tolerance. The product may be affected by environmental installation conditions.

Protections performances can be affected in environments with temperatures below 0°C or higher than 50°C.

The fastness of the colour and its brightness depend on wear and tear and climatic conditions that can affect its intensity over time.

Images in the brochure are for advertising purposes only and do not in any way represent how the products should be used.

Full version of MPM product warranty available in the technical catalogue on corporate websites ([www.mpmprotections.com](http://www.mpmprotections.com)).

